

What Is New Guide

Novell® eDirectory™

8.8 SP3

July 31, 2008

www.novell.com



Legal Notices

Novell, Inc. makes no representations or warranties with respect to the contents or use of this documentation, and specifically disclaims any express or implied warranties of merchantability or fitness for any particular purpose. Further, Novell, Inc. reserves the right to revise this publication and to make changes to its content, at any time, without obligation to notify any person or entity of such revisions or changes.

Further, Novell, Inc. makes no representations or warranties with respect to any software, and specifically disclaims any express or implied warranties of merchantability or fitness for any particular purpose. Further, Novell, Inc. reserves the right to make changes to any and all parts of Novell software, at any time, without any obligation to notify any person or entity of such changes.

Any products or technical information provided under this Agreement may be subject to U.S. export controls and the trade laws of other countries. You agree to comply with all export control regulations and to obtain any required licenses or classification to export, re-export, or import deliverables. You agree not to export or re-export to entities on the current U.S. export exclusion lists or to any embargoed or terrorist countries as specified in the U.S. export laws. You agree to not use deliverables for prohibited nuclear, missile, or chemical biological weaponry end uses. Please refer to www.novell.com/info/exports/ for more information on exporting Novell software. Novell assumes no responsibility for your failure to obtain any necessary export approvals.

Copyright © 2005-2006 Novell, Inc. All rights reserved. No part of this publication may be reproduced, photocopied, stored on a retrieval system, or transmitted without the express written consent of the publisher.

Novell, Inc. has intellectual property rights relating to technology embodied in the product that is described in this document. In particular, and without limitation, these intellectual property rights may include one or more of the U.S. patents listed at <http://www.novell.com/company/legal/patents/> and one or more additional patents or pending patent applications in the U.S. and in other countries.

Novell, Inc.
404 Wyman Street, Suite 500
Waltham, MA 02451
U.S.A.
www.novell.com

Online Documentation: To access the online documentation for this and other Novell products, and to get updates, see www.novell.com/documentation.

Novell Trademarks

Client32 is a trademark of Novell, Inc.

eDirectory is a trademark of Novell, Inc.

NetWare is a registered trademark of Novell, Inc., in the United States and other countries.

NetWare Core Protocol and NCP are trademarks of Novell, Inc.

NMAS is a trademark of Novell, Inc.

Novell is a registered trademark of Novell, Inc., in the United States and other countries.

Novell Client is a trademark of Novell, Inc.

Novell Directory Services and NDS are registered trademarks of Novell, Inc., in the United States and other countries.

Ximian is a registered trademark of Novell, Inc., in the United States and other countries.

ZENworks is a registered trademark of Novell, Inc., in the United States and other countries.

Third-Party Materials

All third-party trademarks are the property of their respective owners.

This product includes software developed by the OpenSSL Project for use in the OpenSSL Toolkit (<http://www.openssl.org>).

Contents

About This Guide	9
1 Install and Upgrade Enhancements	11
1.1 Multiple Package Formats for Installing eDirectory 8.8	12
1.2 Automatic Deployments	12
1.2.1 Upgrade Distributions	12
1.2.2 Easy Deployments	13
1.3 Installing and Configuring eDirectory Through YaST	14
1.4 Installing eDirectory 8.8 in a Custom Location	14
1.4.1 Specifying a Custom Location for Application Files	14
1.4.2 Specifying a Custom Location for Data Files	15
1.4.3 Specifying a Custom Location for Configuration Files	15
1.5 Nonroot Install	16
1.6 Standards Compliance	16
1.6.1 FHS Compliance	16
1.6.2 LSB Compliance	17
1.7 Server Health Checks	17
1.7.1 Need for Health Checks	18
1.7.2 What Makes a Server Healthy?	18
1.7.3 Performing Health Checks	18
1.7.4 Types of Health Checks	19
1.7.5 Categorization of Health	20
1.7.6 Log Files	22
1.8 SecretStore Integration with eDirectory	23
1.9 Unattended Upgrade to eDirectory 8.8 SP1 on Netware	24
1.10 For More Information	24
2 Migrating eDirectory 8.8 SP2 from Netware to OES 2.0	25
3 Multiple Instances	27
3.1 Need for Multiple Instances	27
3.2 Sample Scenarios for Deploying Multiple Instances	27
3.3 Using Multiple Instances	28
3.3.1 Planning the Setup	28
3.3.2 Configuring Multiple Instances	28
3.4 Managing Multiple Instances	29
3.4.1 The ndsmanage Utility	29
3.4.2 Identifying a Specific Instance	32
3.4.3 Invoking a Utility for a Specific Instance	33
3.5 Sample Scenario for Multiple Instances	33
3.5.1 Planning the Setup	33
3.5.2 Configuring the Instances	33
3.5.3 Invoking a Utility for an Instance	34
3.5.4 Listing the Instances	34
3.6 For More Information	34

4	Authentication to eDirectory through SASL-GSSAPI	35
4.1	Concepts	35
4.1.1	What is Kerberos?	35
4.1.2	What is SASL?	35
4.1.3	What is GSSAPI?	36
4.2	How Does GSSAPI Work with eDirectory?	36
4.3	Configuring GSSAPI	37
4.4	How Does LDAP Use GSSAPI?	37
4.5	Commonly Used Terms	38
5	Enforcing Case-Sensitive Universal Passwords	39
5.1	Need for Case-Sensitive Passwords	39
5.2	How to Make Your Password Case-Sensitive	40
5.2.1	Prerequisites	40
5.2.2	Making Your Password Case-Sensitive	40
5.2.3	Managing Case-Sensitive Passwords	41
5.3	Upgrading the Legacy Novell Clients and Utilities	41
5.3.1	Migrating to Case-Sensitive Passwords	41
5.4	Preventing Legacy Novell Clients from Accessing eDirectory 8.8 Server	42
5.4.1	Need for Preventing Legacy Novell Clients from Accessing eDirectory 8.8 Server	42
5.4.2	Managing NDS Login Configurations	43
5.4.3	Partition Operations	46
5.4.4	Enforcing Case-Sensitive Passwords in a Mixed Tree	47
5.5	For More Information	47
6	Priority Sync	49
6.1	Need for Priority Sync	49
6.2	Using Priority Sync	50
6.3	For More Information	50
7	Data Encryption	51
7.1	Encrypting Attributes	51
7.1.1	Need for Encrypted Attributes	51
7.1.2	How to Encrypt Attributes	52
7.1.3	Accessing the Encrypted Attributes	52
7.2	Encrypting Replication	52
7.2.1	Need for Encrypted Replication	52
7.2.2	Enabling Encrypted Replication	53
7.3	For More Information	53
8	Bulkload Performance	55
9	iManager ICE Plug-ins	57
9.1	Adding Missing Schema	57
9.1.1	Add Schema from a File	57
9.1.2	Add Schema from a Server	58
9.2	Comparing the Schema	58
9.2.1	Compare Schema Files	59
9.2.2	Compare Schema between a Server and a File	59
9.3	Generating an Order File	59

9.4	For More Information	59
10	LDAP-Based Backup	61
10.1	Need for LDAP Based Backup.....	61
10.2	For More Information	61
11	Managing Error Logging in eDirectory 8.8	63
11.1	Message Severity Levels	63
11.1.1	Fatal.....	63
11.1.2	Warning	63
11.1.3	Error.....	64
11.1.4	Information.....	64
11.1.5	Debug	64
11.2	Configuring Error Logging	64
11.2.1	Linux and UNIX	64
11.2.2	Windows	65
11.2.3	NetWare.....	67
11.3	DSTrace Messages	68
11.3.1	NetWare, Linux, and UNIX	68
11.3.2	Windows	70
11.4	iMonitor Message Filtering	71
11.5	SAL Message Filtering	72
11.5.1	Configuring the Severity Levels.....	72
11.5.2	Setting the Log File Path	73
12	Offline Bulkload Utility: Idif2dib	75
12.1	Need for Idif2dib.....	75
12.2	For More Information	75
13	eDirectory Backup with SMS	77
14	LDAP Auditing	79
14.1	Need for LDAP Auditing.....	79
14.2	Using LDAP Auditing	79
14.3	For More Information	79
15	Miscellaneous	81
15.1	Security Object Caching.....	81
15.2	Subtree Search Performance Improvement.....	81
15.3	Localhost Changes	82
15.4	256 File Handler on Solaris	82
15.5	Memory Manager on Solaris	82
15.6	Nested Groups.....	82

About This Guide

Welcome to Novell® eDirectory™ 8.8. This guide introduces you to the new features in this product.

eDirectory 8.8 provides a host of new features and enhancements to further strengthen eDirectory's leadership in the directory market.

This guide introduces the following:

- ◆ Chapter 1, “Install and Upgrade Enhancements,” on page 11
- ◆ Chapter 3, “Multiple Instances,” on page 27
- ◆ Chapter 4, “Authentication to eDirectory through SASL-GSSAPI,” on page 35
- ◆ Chapter 5, “Enforcing Case-Sensitive Universal Passwords,” on page 39
- ◆ Chapter 6, “Priority Sync,” on page 49
- ◆ Chapter 7, “Data Encryption,” on page 51
- ◆ Chapter 8, “Bulkload Performance,” on page 55
- ◆ Chapter 9, “iManager ICE Plug-ins,” on page 57
- ◆ Chapter 10, “LDAP-Based Backup,” on page 61
- ◆ Chapter 11, “Managing Error Logging in eDirectory 8.8,” on page 63
- ◆ Chapter 12, “Offline Bulkload Utility: Idif2dib,” on page 75
- ◆ Chapter 15, “Miscellaneous,” on page 81

Audience

The guide is intended for network administrators.

Feedback

We want to hear your comments and suggestions about this manual and the other documentation included with this product. Please use the User Comments feature at the bottom of each page of the online documentation, or go to www.novell.com/documentation/feedback.html and enter your comments there.

Documentation Updates

For the most recent version of this guide, see *Novell eDirectory 8.8 What's New Guide* (<http://www.novell.com/documentation/beta/edir88/edir88new/data/front.html>).

Additional Documentation

For more information about eDirectory 8.8, refer to the following:

- ◆ Novell eDirectory 8.8 Installation Guide
- ◆ Novell eDirectory 8.8 Administration Guide
- ◆ Novell eDirectory 8.8 Troubleshooting Guide

These guides are available at [Novell eDirectory 8.8 documentation Web site \(http://www.novell.com/documentation/edir88/index.html\)](http://www.novell.com/documentation/edir88/index.html).

For information about the eDirectory management utility, see the *Novell iManager 2.6 Administration Guide* (<http://www.novell.com/documentation/imanager26/index.html>).

Documentation Conventions

In this documentation, a greater-than symbol (>) is used to separate actions within a step and items within a cross-reference path.

A trademark symbol (® , ™, etc.) denotes a Novell trademark. An asterisk (*) denotes a third-party trademark.

When a single pathname can be written with a backslash for some platforms or a forward slash for other platforms, the pathname is presented with a backslash. Users of platforms that require a forward slash, such as Linux* and UNIX*, should use forward slashes as required by your software.

Install and Upgrade Enhancements

1

This chapter discusses the new features and enhancements with the Novell® eDirectory™ 8.8 installation and upgrade.

The following table lists the new features and specifies the platforms they are supported on.

Feature	NetWare	Linux	UNIX	Windows
Multiple package formats for installing eDirectory 8.8	✗	✓	✓	✗
Automatic deployment through Ximian® ZENworks® Linux Management 2.2	✗	✓	✗	✗
Install and configure eDirectory through YaST	✗	✓	✗	✗
Custom location install for application files	✗	✓	✓	✓
Custom location install for data files	✗	✓	✓	✓
Custom location install for configuration files	✗	✓	✓	✗
Nonroot install	✗	✓	✓	✗
FHS compliance	✗	✓	✓	✗
LSB compliance	✗	✓	✗	✗
Server health checks	✓	✓	✓	✓
SecretStore integration	✓	✓	✓	✓

The following features are discussed in this chapter:

- ♦ [Multiple Package Formats for Installing eDirectory 8.8 \(page 12\)](#)
- ♦ [Automatic Deployments \(page 12\)](#)
- ♦ [Installing and Configuring eDirectory Through YaST \(page 14\)](#)
- ♦ [Installing eDirectory 8.8 in a Custom Location \(page 14\)](#)
- ♦ [Nonroot Install \(page 16\)](#)
- ♦ [Standards Compliance \(page 16\)](#)
- ♦ [Server Health Checks \(page 17\)](#)
- ♦ [SecretStore Integration with eDirectory \(page 23\)](#)
- ♦ [Unattended Upgrade to eDirectory 8.8 SP1 on Netware \(page 24\)](#)

1.1 Multiple Package Formats for Installing eDirectory 8.8

On Linux* and UNIX, you have an option to choose from various file formats while installing eDirectory 8.8 on your host. The file formats are listed in the table below.

Type of User and Installation Location	Linux	Solaris	AIX
Root user:			
Default location	RPM	Package	File-set
Custom location	Tarball	Package and tarball	Tarball
Nonroot user:			
Custom location	Tarball	Tarball	Tarball

For more information on installing using tarballs, refer to the *Novell eDirectory 8.8 Installation Guide* (<http://www.novell.com/documentation/edir88/edirin88/data/a79kg0w.html#bs6a3gs>).

1.2 Automatic Deployments

eDirectory 8.8 on Linux leverages ZENworks® Linux Management to provide easy upgrade distribution and deployment. For more information, refer to *ZENworks Linux Management* (<http://www.novell.com/products/zenworks/linuxmanagement/index.html>).

1.2.1 Upgrade Distributions

With eDirectory 8.8, you can subscribe to a specific feature that eDirectory offers and whenever there is an update (upgrade or patch) to this feature on the Novell site, you will automatically get this update.

Figure 1-1 Upgrade Distributions

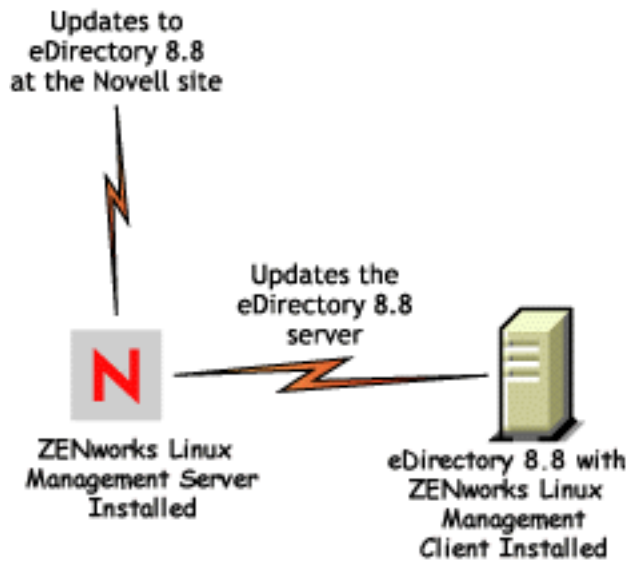

To facilitate this, you need to install the ZENworks Linux Management client on the host where eDirectory 8.8 is present and subscribe to the ZENworks Linux Management server that would inform you when there is an update.

1.2.2 Easy Deployments

With eDirectory 8.8, you can install eDirectory on a host that has the ZENworks Linux Management server installed and then roll it out to the other servers that have installed ZENworks Linux Management clients.

Figure 1-2 eDirectory Distribution through RedCarpet

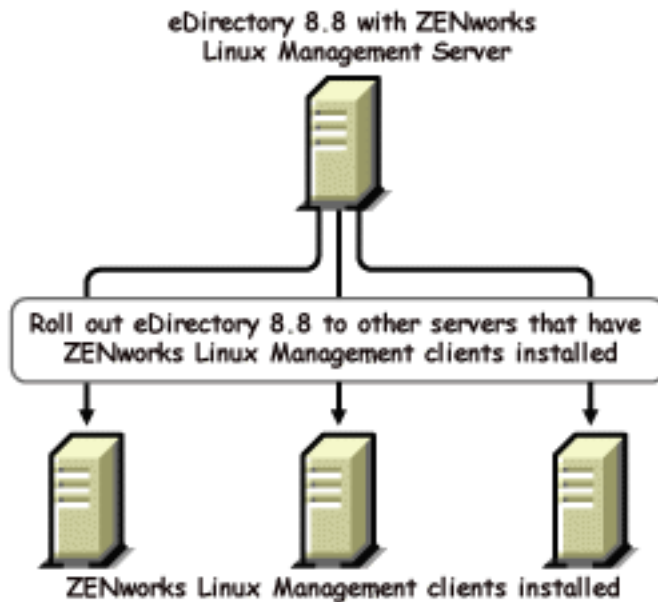

1.3 Installing and Configuring eDirectory Through YaST

On SLES 9.1 or otherwise known as Open Enterprise Server (OES), you can install and configure eDirectory 8.8 through YaST.

For more information on installing and configuring eDirectory through YaST, refer to the *Novell eDirectory 8.8 Installation Guide* (<http://www.novell.com/documentation/edir88/edirin88/data/a79kg0w.html#bv11x18>).

1.4 Installing eDirectory 8.8 in a Custom Location

eDirectory 8.8 gives you the flexibility to install the application, data, and configuration files in a location of your choice.

One of the scenarios for installing eDirectory 8.8 in a custom location is when you already have an earlier version of eDirectory installed on your host and you want to test eDirectory 8.8 before upgrading to it. This way, you can have your existing eDirectory setup undisturbed and also test this new version. You can then decide whether you want to retain your existing version or want to upgrade to eDirectory 8.8.

NOTE: SLP and the SNMP subagent are installed in the default locations.

This section explains how to install the various files in a custom location:

- ♦ [Section 1.4.1, “Specifying a Custom Location for Application Files,” on page 14](#)
- ♦ [Section 1.4.2, “Specifying a Custom Location for Data Files,” on page 15](#)
- ♦ [Section 1.4.3, “Specifying a Custom Location for Configuration Files,” on page 15](#)

1.4.1 Specifying a Custom Location for Application Files

While installing eDirectory, you can install your application files in a location of your choice.

Linux and UNIX

To install eDirectory 8.8 in a custom location, you can use the Tarball installation file and untar eDirectory 8.8 in a location of your choice.

NetWare

You cannot specify a custom location for the application files on NetWare.

Windows

You were able to specify a custom location for the application files during the installation Wizard even prior to eDirectory 8.8.

1.4.2 Specifying a Custom Location for Data Files

While configuring eDirectory, you can save the data files in a location of your choice. The data files include the `data`, `dib`, and `log` directories.

Linux and UNIX

To configure the data files in a custom location, you can use either the `-d` or `-D` option of the `ndsconfig` utility.

Option	Description
<code>-d custom_location</code>	Creates the <code>DIB</code> (the eDirectory database) directory in the path mentioned. NOTE: This option was present prior to eDirectory 8.8 also.
<code>-D custom_location</code>	Creates the <code>data</code> (contains data such as the pids and socket IDs), <code>dib</code> , and <code>log</code> directories in the path mentioned.

NetWare

You cannot select a custom DIB path while upgrading eDirectory. On NetWare, eDirectory installation is always an upgrade. Therefore, you cannot choose a custom DIB path on NetWare.

Windows

On Windows you would be prompted to enter the DIB path during the installation. Enter a path of your choice.

1.4.3 Specifying a Custom Location for Configuration Files

While configuring eDirectory, you can select the path where you want to save your configuration files.

Linux and UNIX

To configure the `nds.conf` configuration file to a different location, use the `--config-file` option of the `ndsconfig` utility.

To install the other configuration files (such as `modules.conf`, `ndsimon.conf`, and `ice.conf`) to a different location, do the following:

- 1 Copy all the configuration files to the new location.
- 2 Set the new location by entering the following:

```
ndsconfig set n4u.nds.configdir custom_location
```

NetWare and Windows

You cannot specify a custom location for the configuration files on NetWare and Windows.

1.5 Nonroot Install

eDirectory 8.8 and up supports installation and configuration of eDirectory servers by a nonroot user. Earlier versions of eDirectory could be installed and configured only by a root user with only a single instance of eDirectory running on a host.

With eDirectory 8.8 or higher, any nonroot user can use a tarball build to install eDirectory. There can be multiple instances of eDirectory binary installs by the same or different users. However, even for non-root user installs, the system-level services such as NICE, SNMP and SLP can be installed only with the root privileges (NICE is a mandatory component, and SNMP and SLP are optional components for eDirectory functionality). Also, with a package install, only a single instance can be installed by the root user.

After the install, a nonroot user can configure eDirectory server instances using his or her individual tarball installation, or by using a binary installation. This means that there can be multiple instances of eDirectory servers running on a single host because any user, either root or non-root, can configure different eDirectory server instances on a single host by using either a package or tarball install. For more details on the Multiple Instances feature, refer to [Multiple Instances](#) and [Upgrading Multiple Instances](#) (<http://www.novell.com/documentation/edir88/edirin88/data/af7r5d7.html>).

Nonroot installation and configuration is applicable to Linux and UNIX platforms only. For more information on nonroot installation and configuration, refer to [Nonroot User Installing eDirectory 8.8](#) (<http://www.novell.com/documentation/edir88/edirin88/data/ai3a2wy.html>).

1.6 Standards Compliance

eDirectory 8.8 is compliant with the following standards:

- ♦ [Section 1.6.1, “FHS Compliance,” on page 16](#)
- ♦ [Section 1.6.2, “LSB Compliance,” on page 17](#)

1.6.1 FHS Compliance

To avoid file conflicts with other product application files, eDirectory 8.8 follows the Filesystem Hierarchy Standard (FHS). This feature is available only on Linux and UNIX.

eDirectory follows this directory structure only if you have chosen to install it in the default location. If you have chosen a custom location, the directory structure would be *custom_location/default_path*.

For example, if you choose to install in the `eDir88` directory, the same directory structure would be followed in the `eDir88` directory, like the man pages would be installed in the `/eDir88/opt/novell/man` directory.

The following table lists the change in the directory structure:

Types of Files Stored in the Directory	Directory Name and Path
Executable binaries and static shell scripts	<code>/opt/novell/eDirectory/bin</code>
Executable binaries for root use	<code>/opt/novell/eDirectory/sbin</code>
Static or dynamic library binaries	<code>/opt/novell/eDirectory/lib</code>

Types of Files Stored in the Directory	Directory Name and Path
Configuration files	/etc/opt/novell/eDirectory/conf
Read/Write, run-time dynamic data like the DIB	/var/opt/novell/eDirectory/data
Log files	/var/opt/novell/eDirectory/log
Linux and UNIX man pages	/opt/novell/man

Export Environmental Variables

With the FHS implementation in eDirectory 8.8, you need to update the path environmental variables and export them. This creates the following problems:

- ♦ You need to remember all the paths exported, so that whenever you open a shell, you need to export these paths and start using the utilities.
- ♦ When you want to use more than one set of binary, you have to open more than one shell or have to unset and set the paths to the different set of binaries frequently.

To resolve the above issue, you can use the `/opt/novell/eDirectory/bin/ndspath` script as follows:

- ♦ Prefix the `ndspath` script to the utility and run the utility you want as follows:

```
custom_location/opt/novell/eDirectory/bin/ndspath utility_name_with_parameters
```

- ♦ Export the paths in the current shell as follows:

```
. custom_location/opt/novell/eDirectory/bin/ndspath
```

- ♦ After entering the above command, run the utilities as you would normally do. Call the script in your profile, `bashrc`, or similar scripts. Therefore, whenever you log in or open a new shell, you can start using the utilities directly.

1.6.2 LSB Compliance

eDirectory 8.8 is now Linux Standard Base (LSB) compliant. LSB also recommends FHS compliance. All the eDirectory packages in Linux are prefixed with *novell*. For example, `NDSserv` is now `novell-NDSserv`.

1.7 Server Health Checks

eDirectory 8.8 introduces server health checks that help you determine whether your server health is safe before upgrading.

The server health checks run by default with every upgrade and occur before the actual package upgrade. However, you can also run the diagnostic tool `ndsccheck` (or `dscheck` on NetWare) to do the health checks.

1.7.1 Need for Health Checks

In earlier releases of eDirectory, the upgrade did not check the health of the server before proceeding with the upgrade. If the health was unstable, the upgrade operation would fail and eDirectory would be in an inconsistent state. In some cases, you probably could not roll back to the pre-upgrade settings.

This new health check tool resolves this, letting you to ensure that your server is ready to upgrade.

1.7.2 What Makes a Server Healthy?

The server health check utility performs certain **health checks** to ensure that the tree is healthy. The tree is declared healthy when all these health checks are completed successfully.

1.7.3 Performing Health Checks

You can perform server health checks in two ways:

- ♦ “With the Upgrade” on page 18
- ♦ “As a Standalone Utility” on page 18

NOTE: You need administrative rights to run the health check utility.

With the Upgrade

The health checks are run by default every time you upgrade eDirectory.

Linux and UNIX

Every time you upgrade, the health checks are run by default before the actual upgrade operation starts.

To skip the default health checks, you can use the `-j` option with the `nds-install` utility.

NetWare and Windows

The server health checks happen as part of the installation wizard. You can enable or disable the health checks when prompted to do so.

As a Standalone Utility

You can run the server health checks as a standalone utility any time you want. The following table explains the health check utilities.

Table 1-1 Health Check Utilities

Platform	Utility Name
Linux and UNIX	ndscheck Syntax: <pre>ndscheck -h hostname:port -a admin_FDN -F logfile_path --config-file configuration_file_name_and_path</pre>
	NOTE: You can specify either -h or --config-file and not both of them.
NetWare	dscheck
Windows	ndscheck

1.7.4 Types of Health Checks

When you upgrade or run the ndscheck utility, the following types of health checks are done:

- ♦ **Basic Server Health**
- ♦ **Partitions and Replica Health**

If you run the ndscheck utility, the results from the health checks are displayed on the screen and logged in to `ndscheck.log` (or `dscheck.log` on NetWare). For more information on log files, refer to [Section 1.7.6, “Log Files,” on page 22](#).

If the health checks are done as part of the upgrade, then after the health checks, based on the criticality of the error, either you are prompted to continue the upgrade process or the process is aborted. The details of the errors are described in [Section 1.7.5, “Categorization of Health,” on page 20](#).

Basic Server Health

This is the first stage of the health check. The health check utility checks for the following:

1. The eDirectory service is up. The DIB is open and able to read some basic tree information such as the tree name.
2. The server is listening on the respective port numbers.

For LDAP, it gets the TCP and the SSL port numbers and checks if the server is listening on these ports.

Similarly, it gets the HTTP and HTTP secure port numbers and checks if the server is listening on these ports.

Partitions and Replica Health

After checking the basic server health, the next step is to check the partitions and replica health as follows:

1. Checks the health of the replicas of the locally held partitions.

2. Reads the replica ring of each and every partition held by the server and checks whether all servers in the replica ring are up and all the replicas are in the ON state.
3. Checks the time synchronization of all the servers in the replica ring. This shows the time difference between the servers.

1.7.5 Categorization of Health

Based on the errors found while checking the health of a server, there can be the three categories of health. The status of the health checks is logged in to a logfile. For more information, refer to [Section 1.7.6, “Log Files,” on page 22](#).

The three categories of health **Normal**, **Warning**, and **Critical**.

Normal

The server health is normal when all the health checks were successful.

The upgrade proceeds without interruption.

Warning

The server health is in the warning category when minor errors are found while checking the health.

If the health check is run as part of the upgrade, you are prompted to either abort or continue.

Warnings normally occur in the following scenarios:

1. Server not listening on LDAP and HTTP ports, either normal or secure or both.
2. Unable to contact any of the nonmaster servers in the replica ring.
3. Servers in the replica ring are not in sync.

For more information, see the following figure.

Figure 1-3 Health Check with a Warning

```

osg-dt-srv27</>ndsconfig upgrade -a admin.org
[[1 Instance at /etc/opt/novell/eDirectory/conf/nds.conf: osg-dt-srv27.org.SOLT
0615
Enter the password for admin.org:
Starting health check...
Mon Jun 21 08:20:48 2004
Performing health check on the eDirectory server ".CN=osg-dt-srv27.0=org.T=SOLT0
615." ...
-----
Checking the LDAP and HTTP configuration...
WARNING: eDirectory server is not listening on the LDAP port 389
WARNING: eDirectory server is not listening on the LDAP port 636
Checking health of partitions ...

Status of partition ".T=SOLT0615." ... [OK]
Checking the status of the replica ring...
Number of replicas = 2
-----+-----+-----+-----+-----+
Server Name                Status  Time Sync  Time Delta  Replica S
tate
-----+-----+-----+-----+-----+
.CN=osg-dt-srv27.0=org.T=SOLT0615.    UP      YES        0 m:0 s     ON
.CN=osg-dt-srv9.0=org.T=SOLT0615.     UP      YES        0 m:23 s    ON
-----+-----+-----+-----+-----+

Checking replication delta on the partition...
Maximum replica ring delta "0:3:35 <hh:mm:ss>"
Perishable delta on this server: "0:3:35 <hh:mm:ss>"

eDirectory health check completed.

Errors were detected during the server health check. Refer log file "/var/opt/no
vell/eDirectory/data/./log/ndscheck.log" for more details.

For a possible solution refer the following locations -
1. Cool solutions: http://www.novell.com/cool/solutions/nds/
2. Support forums: http://support.novell.com/forums/2ed.html
3. Documentation (trouble shooting section): http://www.novell.com/documentati
on/edirectory.html
4. Error codes: http://www.novell.com/documentation/lg/nwec/index.html
5. Patches: http://support.novell.com/filefinder/5069/index.html

WARNING: Errors were detected during the server health check.
Continue <y/n>? _

```

Critical

The server health is critical when critical errors were found while checking the health.

If the health check is run as part of the upgrade, the upgrade operation is aborted.

The critical state normally occurs in the following cases:

1. Unable to read or open the DIB. The DIB might be locked or corrupt.
2. Unable to contact all the servers in the replica ring.
3. Locally held partitions are busy.
4. Replica is not in the ON state.

For more information, see the following figure.

Figure 1-4 Health Check with a Critical Error

```
osg-dt-srv27</>ndsconfig upgrade -a admin.org
[[1] Instance at /etc/opt/novell/eDirectory/conf/nds.conf: osg-dt-srv27.org.SOLT
0615
Enter the password for admin.org:

Starting health check...
Mon Jun 21 08:14:46 2004
Performing health check on the eDirectory server ".CN=osg-dt-srv27.0=org.T=SOLT0
615." ...

-----
Checking the LDAP and HTTP configuration... [OK]
Checking health of partitions ...

Status of partition ".T=SOLT0615." ... [OK]
Checking the status of the replica ring...
Number of replicas = 2
+-----+-----+-----+-----+
| Server Name                               | Status | Time Sync | Time Delta | Replica S |
| tate                                       |        |           |            | tate      |
+-----+-----+-----+-----+
|.CN=osg-dt-srv27.0=org.T=SOLT0615.        | UP     | YES       | 0 m:0 s    | ON        |
|.CN=osg-dt-srv9.0=org.T=SOLT0615.         | DOWN  | -         | -          | ON        |
+-----+-----+-----+-----+
-----+

Checking replication delta on the partition...
Maximum replica ring delta "0:0:23 (hh:mm:ss)"
Perishable delta on this server: "0:0:0 (hh:mm:ss)"

eDirectory health check completed.

Errors were detected during the server health check. Refer log file "/var/opt/no
vell/eDirectory/data/./log/ndscheck.log" for more details.

For a possible solution refer the following locations -
1. Cool solutions: http://www.novell.com/cool solutions/nds/
2. Support forums: http://support.novell.com/forums/2ed.html
3. Documentation (trouble shooting section): http://www.novell.com/documentati
on/edirectory.html
4. Error codes: http://www.novell.com/documentation/lg/nwec/index.html
5. Patches: http://support.novell.com/filefinder/5069/index.html

ERROR 2: Check the errors before continuing with the eDirectory upgrade.
osg-dt-srv27</>_
```

1.7.6 Log Files

Every server health check operation, whether it is run with the upgrade or as a standalone utility, maintains the status of the health in a log file.

The content of the log file is similar to the messages displayed on the screen when the checks are happening. For example, see [Figure 1-3](#) and [Figure 1-4](#) above.

The health check log file contains the following:

- ◆ Status of the health checks (normal, warning, or critical).
- ◆ URLs to the Novell support site.

The following table gives you the locations for the log file on the various platforms:

Table 1-2 Health Check Logfile Locations

Platform	Logfile Name	Logfile Location
Linux and UNIX	<code>ndscheck.log</code>	Depends on the location you specified with the <code>ndscheck -F</code> utility. If you did not use the <code>-F</code> option, the location of the <code>ndscheck.log</code> file is determined by the other options you used at the <code>ndscheck</code> command line as follows: <ol style="list-style-type: none">1. If you used the <code>-h</code> option, the <code>ndscheck.log</code> file is saved in the user's home directory.2. If you used the <code>--config-file</code> option, the <code>ndscheck.log</code> file is saved in the server instance's log directory. You can also select an instance from the multiple instances list.
NetWare	<code>dscheck.log</code>	<code>sys:\system</code>
Windows	<code>ndscheck.log</code>	<code>install_directory</code>

1.8 SecretStore Integration with eDirectory

eDirectory 8.8 gives you an option to configure Novell SecretStore[®] 3.4 during eDirectory configuration. Prior to eDirectory 8.8, you had to manually install SecretStore.

SecretStore is a simple and secure password management solution. It enables you to use a single authentication to eDirectory to access most UNIX, Windows, Web, and mainframe applications.

After you've authenticated to eDirectory, SecretStore-enabled applications store and retrieve the appropriate login credentials. When you use SecretStore, you eliminate the need to remember or synchronize all the multiple passwords required for accessing password-protected applications, Web sites, and mainframes.

To configure SecretStore 3.4 along with eDirectory, you can do the following:

- ◆ **Linux and UNIX:**

Use the `ndsconfig add -m ss` parameter. Here, `ss` denotes SecretStore and is an optional parameter. If you do not mention the module name, all the modules are installed.

- ◆ **NetWare and Windows:**

Installed by default with eDirectory installation.

For more information on the SecretStore usage, refer to the *Novell SecretStore Administration Guide* (<http://www.novell.com/documentation/secretstore33/index.html>).

1.9 Unattended Upgrade to eDirectory 8.8 SP1 on Netware

Novell® ZENworks® Server Management provides the Server Software Packages component for managing files and applications on your network. Using software packages, you can automate the installation and upgrading of software on your servers. Software management is done by creating Server Software Packages and distributing them using Tiered Electronic Distribution. You can configure Server Software Packages so that a server must meet certain minimum requirements before a package is installed on it.

The automated upgrade for eDirectory on Netware for ZFS environment is delivered as SPK along with the source. SPK has to be inserted into the ConsoleOne “Server Software Packages” snap-in for customizing into local environments. Once the Server Software Package ConsoleOne snap-in is installed, you can insert this SPK in the ConsoleOne.

The compiled CPK is not provided since the user is expected to provide values for the variables containing administrator credentials. This SPK needs to be compiled to a CPK in the customer site after providing values to these variables.

For more information on this utility, refer to “Unattended Upgrade to eDirectory 8.8 SP1 on Netware” of eDirectory 8.8 Installation Guide.

1.10 For More Information

Refer to the following for more information on any of the features discussed in this chapter:

- ♦ *Novell eDirectory 8.8 Installation Guide* (<http://www.novell.com/documentation/edir88/edirin88/data/a2iii88.html>)
- ♦ *Novell eDirectory 8.8 Administration Guide* (<http://www.novell.com/documentation/edir88/edir88/data/fbadjaeh.html#fbadjach>)
- ♦ On Linux and UNIX: `nds-install`, `ndsconfig`, and `ndscheck` man pages

Migrating eDirectory 8.8 SP2 from Netware to OES 2.0

2

eDirectory migration utility allows administrators to transfer data and services from an existing server to another location on a Cypress server in the same eDirectory tree. In addition to moving data, it is possible move the identity of the server box onto the new box.

Migrating eDirectory from NetWare primarily requires the migration of the data and the eDirectory server identity to provide seamless accessibility after the migration. The migration process involves pre-migration tasks, server backups, server state and health validations; server migration and post-migration tasks.

eDirectory migration is performed through three major tasks that get plugged-in as part of the Cypress migration tool. This tool along with other subcomponents provides the server migration and consolidation service for migration to Cypress environment.

IMPORTANT: The eDirectory migration utility is designed to run on Linux versions of Cypress which will be the target platforms for migration. Hardware and supported platform requirements are aligned with the corresponding Cypress supported platform matrix.

For more information, refer to [Novell eDirectory Installation Guide \(http://www.novell.com/documentation/edir88/edirin88/data/a2iii88.html\)](http://www.novell.com/documentation/edir88/edirin88/data/a2iii88.html).

Multiple Instances

Traditionally, you could configure only one instance of Novell® eDirectory™ on a single host. With the multiple instances feature support in eDirectory 8.8, you can configure the following:

- ♦ Multiple instances of eDirectory on a single host
- ♦ Multiple trees on a single host
- ♦ Multiple replicas of the same tree or partition on a single host

eDirectory 8.8 also provides you with a utility ([ndsmanage](#)) to easily track the instances.

The following table lists the platforms that support the multiple instances:

Feature	NetWare	Linux	UNIX	Windows
Multiple instances support	✗	✓	✓	✗

This chapter includes the following information:

- ♦ [Section 3.2, “Sample Scenarios for Deploying Multiple Instances,” on page 27](#)
- ♦ [Section 3.3, “Using Multiple Instances,” on page 28](#)
- ♦ [Section 3.4, “Managing Multiple Instances,” on page 29](#)
- ♦ [Section 3.5, “Sample Scenario for Multiple Instances,” on page 33](#)

3.1 Need for Multiple Instances

Multiple instances arose from the need to:

- ♦ Leverage high-end hardware by configuring more than one instance of eDirectory.
- ♦ Pilot your setup on a single host before investing on the required hardware.

3.2 Sample Scenarios for Deploying Multiple Instances

Multiple instances that belong to the same or multiple trees can be used in the following scenarios effectively.

eDirectory in a Large Enterprise

- ♦ In large enterprises, you can provide load balancing and high availability of eDirectory services.

For example, if you have three replica servers running LDAP services on ports 1524, 2524, and 3524, respectively, you can configure a new instance of eDirectory and provide a high-availability LDAP service on a new port 636.

- ♦ You can leverage high-end hardware across departments in an organization by configuring multiple instances on a single host.

eDirectory in an Evaluation Setup

- ♦ **Universities:** Many enthusiasts (students) can evaluate eDirectory from the same host using the multiple instances.
- ♦ **Training for eDirectory administration:**
 - ♦ Participants can try out administration using the multiple instances.
 - ♦ Instructors can use a single host to teach a class of students. Each student can have his own tree.

3.3 Using Multiple Instances

eDirectory 8.8 makes it very easy for you to configure multiple instances. To effectively use multiple instances, you need to plan the setup and then configure the multiple instances.

- ♦ [Section 3.3.1, “Planning the Setup,” on page 28](#)
- ♦ [Section 3.3.2, “Configuring Multiple Instances,” on page 28](#)

3.3.1 Planning the Setup

To use this feature effectively, we recommend that you plan the eDirectory instances and ensure that each instance has definite instance identifiers like the hostname, port number, server name, or the configuration file.

While configuring multiple instances, you need to ensure that you have planned for the following:

- ♦ Location of the configuration file
- ♦ Location of the variable data (like log files)
- ♦ Location of the DIB
- ♦ NCP™ interface, unique identifying port for every instance, and ports of other services (like LDAP, LDAPS, HTTP, and HTTP secure port)
- ♦ Unique server name for every instance

3.3.2 Configuring Multiple Instances

You can configure multiple instances of eDirectory using the `ndsconfig` utility. The following table lists the `ndsconfig` options you need to include when configuring multiple instances.

NOTE: All the instances share the same server key (NICI).

Option	Description
<code>--config-file</code>	Specifies the absolute path and filename to store the <code>nds.conf</code> configuration file. For example, to store the configuration file in the <code>/etc/opt/novell/eDirectory/</code> directory, use <code>--config-file /etc/opt/novell/eDirectory/nds.conf</code> .

Option	Description
-b	Specifies the port number where the new instance should listen. NOTE: -b and -B are exclusively used.
-B	Specifies the port number along with the IP address or interface. For example: -B eth0@524 or -B 100.1.1.2@524 NOTE: -b and -B are exclusively used.
-D	Creates the <code>data</code> , <code>dib</code> , and <code>log</code> directories in the path specified for the new instance.
S	Specifies the server name.

Using the above-mentioned options, you can configure a new instance of eDirectory.

You can also configure a new instance using the `ndsmanage` utility. For more information, refer to [“Creating an Instance through ndsmanage” on page 30](#).

3.4 Managing Multiple Instances

This section includes the following information:

- ♦ [Section 3.4.1, “The ndsmanage Utility,” on page 29](#)
- ♦ [Section 3.4.2, “Identifying a Specific Instance,” on page 32](#)
- ♦ [Section 3.4.3, “Invoking a Utility for a Specific Instance,” on page 33](#)

3.4.1 The ndsmanage Utility

The `ndsmanage` utility enables you to do the following:

- ♦ [List the instances configured](#)
- ♦ [Create a new instance](#)
- ♦ [Do the following for a selected instance:](#)
 - ♦ List the replicas on the server
 - ♦ Start the instance
 - ♦ Stop the instance
 - ♦ Run `ndstrace` for the instance
 - ♦ Deconfigure the instance
- ♦ [Start and Stop all instances](#)

Listing the Instances

The following table describes how to list the eDirectory instances.

Table 3-1 *ndsmanage Usage for Listing the Instances*

Syntax	Description
ndsmanage	Lists all the instances configured by you.
ndsmanage -a --all	List instances of all the users who are using a particular installation of eDirectory.
ndsmanage <i>username</i>	List the instances configured by a specific user

The following fields are displayed for every instance:

- ◆ Configuration file path
- ◆ Server FDN and port
- ◆ Status (whether the instance is active or inactive)

NOTE: This utility lists all the instances configured for a single binary.

Refer to [Figure 3-1 on page 30](#) for more information.

Creating an Instance through ndsmanage

To create a new instance through ndsmanage:

- 1 Enter the following command:

```
ndsmanage
```

If you have two instances configured, the following screen is displayed:

Figure 3-1 *ndsmanage Utility Output Screen*

```
root@MYSOL-8 / $ ndsmanage

The following are the instances configured by root

[1] /etc/opt/novell/eDirectory/conf/nds.conf : .MYSOL-8.NOVELL.88SOL. : 164.99.148.175
@524 : ACTIVE

[2] /builds/server2/eDirectory/nds.conf : .MYSOL-8.NOVELL.88SOL. : 164.99.148.175
@1525 : ACTIVE

Enter [1 - 2] for more options, [c] for creating a new instance or [q] to quit: █
```

- 2 Enter c to create a new instance.

You can either create a new tree or add a server to an existing tree. Follow the instructions on the screen to create a new instance.

Performing Operations for a Specific Instance

You can perform the following operations for every instance:

- ♦ “Starting a Specific Instance” on page 31
- ♦ “Stopping a Specific Instance” on page 31
- ♦ “Deconfiguring an Instance” on page 32

Other than the ones listed above, you can also run `ndstrace` for a selected instance.

Starting a Specific Instance

To start an instance configured by you, do the following:

- 1 Enter the following:

```
ndsmanage
```

- 2 Select the instance you want to start.

The menu expands to include the options you can perform on a specific instance.

Figure 3-2 *ndsmanage Utility Output Screen with Instance Options*

```
root@mysol-8 / $ ndsmanage root

The following are the instances configured by root

[1] /etc/opt/novell/eDirectory/conf/nds.conf : .MYSOL-8.NOVELL.88SOL. : 164.99.148.175
@524 : ACTIVE

[2] /builds/server2/eDirectory/nds.conf : .MYSOL-8.NOVELL.88SOL. : 164.99.148.175
@1525 : ACTIVE

Enter [1 - 2] for more options, [c] for creating a new instance or [q] to quit: 1
[1] List the replicas on the server
[s] Start the instance
[k] Stop the instance
[t] Run ndstrace
[d] Deconfigure
[q] Quit
What do you want to do with this instance? [ Choose from above]: █
```

- 3 Enter `s` to start the instance.

Alternatively, you can also enter the following at the command prompt:

```
ndsmanage start --config-file
configuration_file_of_the_instance_configured_by_you
```

Stopping a Specific Instance

To stop an instance configured by you, do the following:

- 1 Enter the following:

```
ndsmanage
```

- 2 Select the instance you want to stop.

The menu expands to include the options you can perform on a specific instance. For more information, refer to [ndsmanage Utility Output Screen with Instance Options \(page 31\)](#).

- 3 Enter `k` to stop the instance.

Alternatively, you can also enter the following at the command prompt:

```
ndsmanage stop --config-file  
configuration_file_of_the_instance_configured_by_you
```

Deconfiguring an Instance

To deconfigure an instance, do the following:

- 1 Enter the following:

```
ndsmanage
```

- 2 Select the instance you want to deconfigure.

The menu expands to include the options you can perform on a specific instance. For more information, refer to [ndsmanage Utility Output Screen with Instance Options \(page 31\)](#).

- 3 Enter `d` to deconfigure the instance.

Starting and Stopping All Instances

You can start and stop all the instances configured by you.

Starting all the Instances

To start all the instances configured by you, enter the following at the command prompt:

```
ndsmanage startall
```

To start a specific instance, refer to [“Starting a Specific Instance” on page 31](#).

Stopping All Instances

To stop all the instances configured by you, enter the following at the command prompt:

```
ndsmanage stopall
```

To stop a specific instance, refer to [“Stopping a Specific Instance” on page 31](#).

3.4.2 Identifying a Specific Instance

While configuring multiple instances, you assign a hostname, port number, and a unique configuration file path to every instance. This hostname and port number are the instance identifiers.

Most of the utilities have the `-h hostname:port` or `--config-file configuration_file_location` option that enables you to specify a particular instance. See the man pages of the utilities for more information.

3.4.3 Invoking a Utility for a Specific Instance

If you want to run a utility for a specific instance, you need to include the instance identifier in the utility command. The instance identifiers are the path of the configuration file, and the hostname and port number. You can use the `--config-file configuration_file_location` or the `-h hostname:port` to do so.

If you do not include the instance identifiers in the command, the utility displays the various instances you own and prompts you to select the instance you want to run the utility for.

For example, to run `ndstrace` for a specific utility using the `--config-file` option, you would enter the following:

```
ndstrace --config-file configuration_filename_with_location
```

3.5 Sample Scenario for Multiple Instances

Mary is a nonroot user who wants to configure two trees on a single host machine for a single binary.

3.5.1 Planning the Setup

Mary specifies the following instance identifiers.

- ◆ **Instance 1:**

Port number the instance should listen on	1524
Configuration file path	/home/maryinst1/nds.conf
DIB directory	/home/mary/inst1/var

- ◆ **Instance 2:**

Port number the instance should listen on	2524
Configuration file path	/home/mary/inst2/nds.conf
DIB directory	/home/mary/inst2/var

3.5.2 Configuring the Instances

To configure the instances based on the above mentioned instance identifiers, Mary must enter the following commands.

- ◆ **Instance 1:**

```
ndsconfig new -t mytree -n o=novell -a cn=admin.o=company -b 1524 -D  
/home/mary/inst1/var --config-file /home/mary/inst1/nds.conf
```

- ◆ **Instance 2:**

```
ndsconfig new -t corptree -n o=novell -a cn=admin.o=company -b 2524 -D  
/home/mary/inst2/var --config-file /home/mary/inst2/nds.conf
```

3.5.3 Invoking a Utility for an Instance

If Mary wants to run the `ndstrace` utility for instance 1 that is listening on port 1524, with its configuration file in `/home/mary/inst1/nds.conf` location and its DIB file located in `/home/mary/inst1/var`, then she can run the utility as follows:

```
ndstrace --config-file /home/mary/inst1/nds.conf
```

or

```
ndstrace -h 164.99.146.109:1524
```

If Mary does not specify the instance identifiers, the utility displays all the instances owned by Mary and prompts her to select an instance.

3.5.4 Listing the Instances

If Mary wants to know details about the instances in the host, she can run the `ndsmanage` utility.

- ♦ To display all instances owned by Mary:

```
ndsmanage
```

- ♦ To display all instances owned by John (username is john):

```
ndsmanage john
```

- ♦ To display all instances of all users that are using a particular installation of eDirectory:

```
ndsmanage -a
```

3.6 For More Information

Refer to the following documents for more information about Multiple Instances Support:

- ♦ *Novell eDirectory 8.8 Install Guide* (<http://www.novell.com/documentation/edir88/edirin88/data/a79kg0w.html#bqs8mmt>)
- ♦ For Linux and UNIX: `ndsconfig` and `ndsmanage` man pages

Authentication to eDirectory through SASL-GSSAPI

4

The SASL-GSSAPI mechanism for Novell® eDirectory™ 8.8 enables you to authenticate to eDirectory through LDAP using a Kerberos* ticket and without needing to enter the eDirectory user password. The Kerberos ticket should be obtained by authenticating to a Kerberos server.

This feature is primarily useful for LDAP application users in environments that already have a Kerberos infrastructure in place. Therefore, these users should be able to authenticate to the LDAP server without providing a separate LDAP user password.

To facilitate this, eDirectory introduces the SASL-GSSAPI mechanism.

The current implementation of SASL-GSSAPI is compliant with RFC 2222 (<http://www.ietf.org/rfc/rfc2222.txt?number=2222>) and supports only Kerberos v5 as the authentication mechanism.

This chapter includes the following information:

- ♦ Section 4.1, “Concepts,” on page 35
- ♦ Section 4.2, “How Does GSSAPI Work with eDirectory?,” on page 36
- ♦ Section 4.3, “Configuring GSSAPI,” on page 37
- ♦ Section 4.4, “How Does LDAP Use GSSAPI?,” on page 37
- ♦ Section 4.5, “Commonly Used Terms,” on page 38

4.1 Concepts

- ♦ Section 4.1.1, “What is Kerberos?,” on page 35
- ♦ Section 4.1.2, “What is SASL?,” on page 35
- ♦ Section 4.1.3, “What is GSSAPI?,” on page 36

4.1.1 What is Kerberos?

Kerberos is a standard protocol that provides a means of authenticating entities on a network. It is based on a trusted third-party model. It involves shared secrets and uses symmetric key cryptography.

For more information, refer to RFC 1510 (<http://www.ietf.org/rfc/rfc1510.txt?number=1510>).

For more information on Novell Kerberos KDC, refer to the [Novell Kerberos KDC documentation](http://www.novell.com/documentation/kdc/index.html) (<http://www.novell.com/documentation/kdc/index.html>).

4.1.2 What is SASL?

Simple Authentication and Security Layer (SASL) provides an authentication abstraction layer to applications. It is a framework that authentication modules can be plugged into.

For more information, refer to RFC 2222 (<http://www.ietf.org/rfc/rfc2222.txt?number=2222>).

4.1.3 What is GSSAPI?

Generic Security Services Application Program Interface (GSSAPI) provides authentication and other security services through a standard set of APIs. It supports different authentication mechanisms; Kerberos v5 is the most common.

For more information on the GSS APIs, refer to [RFC 1964 \(http://www.ietf.org/rfc/rfc1964.txt?number=1964\)](http://www.ietf.org/rfc/rfc1964.txt?number=1964).

This SASL-GSSAPI implementation is from section 7.2 of [RFC 2222 \(http://www.ietf.org/rfc/rfc2222.txt?number=2222\)](http://www.ietf.org/rfc/rfc2222.txt?number=2222).

4.2 How Does GSSAPI Work with eDirectory?

The following diagram illustrates how GSSAPI works with an LDAP server.

Figure 4-1 How GSSAPI Works?

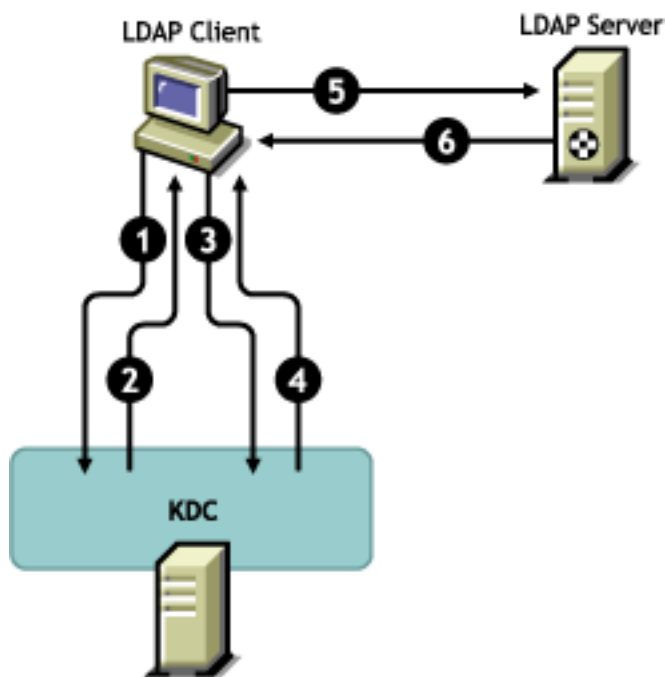

In the above figure, the numbers denote the following:

- 1 An eDirectory user sends a request through an LDAP client to the Kerberos KDC (Key Distribution Center) server for an initial ticket known as a ticket granting ticket (TGT). A Kerberos KDC can be from Novell Kerberos KDC MIT, Microsoft*, or Heimdal.
- 2 KDC responds to the LDAP client with a TGT.
- 3 The LDAP client sends the TGT back to the KDC and requests an LDAP service ticket.
- 4 KDC responds to the LDAP client with the LDAP service ticket.

- 5 The LDAP client does an `ldap_sasl_bind` to the LDAP server and sends the LDAP service ticket.
- 6 The LDAP server validates the LDAP service ticket with the help of the GSSAPI mechanism and, based on the result, sends back an `ldap_sasl_bind` success or failed to the LDAP client.

4.3 Configuring GSSAPI

- 1 The iManager plug-in for SASL-GSSAPI will not work if iManager is not configured to use SSL/TLS connection to eDirectory. A secure connection is mandated to protect the realm's master key and principal keys.

By default, iManager is usually configured for SSL/TLS connection to eDirectory. If you want to configure the Kerberos Login Method for GSSAPI on a tree other than the one that hosts the iManager configuration, you need to configure iManager for SSL/TLS connection to eDirectory.

For information on configuring iManager with SSL/TLS connection to eDirectory, refer to the *iManager 2.6 Administration Guide* (<http://www.novell.com/documentation/lg/imanager20/index.html?page=/documentation/lg/imanager20/imanager20/data/am4ajce.html#bow4dv4>).

The iManager plug-in for SASL-GSSAPI (`kerberosPlugin.npm`) is available as a part of both `eDir_88_iMan26_Plugins.npm` and `eDir_88_iMan27_Plugins.npm` files. Download the NPMs from the [Web](http://download.novell.com) (<http://download.novell.com>).

- 2 To use a Kerberos ticket to authenticate to an eDirectory server:

- 2a Extend the Kerberos schema.
- 2b Create a Realm container.
- 2c Extract a Service Principal Key or Shared Key from KDC.
- 2d Create the LDAP Service Principal object.
- 2e Associate a Kerberos principal name with the User Object.

For information on the above steps, refer to the *Configuring GSSAPI with eDirectory in Novell eDirectory 8.8 Administration Guide* (<http://www.novell.com/documentation/edir88/index.html?tree=titl.html>)

4.4 How Does LDAP Use GSSAPI?

After you configure GSSAPI, it is added along with the other SASL methods to the `supportedSASLMechanisms` attribute in `rootDSE`. `RootDSE` (DSA [Directory System Agent] Specific Entry) is an entry that is located at the root of the Directory Information Tree (DIT). For more information, refer to the *Novell eDirectory 8.8 Administration Guide* (<http://www.novell.com/documentation/edir88/edir88/data/h0000007.html#a680dyc>).

The LDAP server queries SASL for the installed mechanisms when it gets its configuration and automatically supports whatever is installed. The LDAP server also reports the current supported SASL mechanisms in its `rootDSE` by using the `supportedSASLMechanisms` attribute.

Therefore, when you configure GSSAPI, it becomes the default mechanism. However, to specifically do an LDAP operation over the SASL GSSAPI mechanism, you can mention GSSAPI at the command line.

For example, to do a search in OpenLDAP using the GSSAPI mechanism, you would enter the following:

```
ldapsearch -Y GSSAPI -h 164.99.146.48 -b "" -s base
```

4.5 Commonly Used Terms

The following table defines the terminologies commonly used with Kerberos and GSSAPI.

Table 4-1 *Kerberos/GSSAPI Terminology*

Term	Definition
Key Distribution Center (KDC)	Kerberos server which authenticates users and issues tickets.
Principal	An entity (user or service instance) registered with the KDC.
Realm	A domain or grouping of principals served by a set of KDCs.
Service Ticket (ST)	A record containing client information, service information, and a session key which is encrypted with the particular service principal's shared key
Ticket Granting Ticket (TGT)	A type of ticket that the client can obtain additional Kerberos tickets with.

Enforcing Case-Sensitive Universal Passwords

In Novell® eDirectory™ 8.8, you can enable Universal Password and make your password case-sensitive when you access the eDirectory 8.8 server through the following clients and utilities:

- ♦ Novell Client™ 4.9 and later
- ♦ Administration utilities upgraded to eDirectory 8.8
- ♦ Novell iManager 2.6 and later, except when it is running on Windows

You can use any version of LDAP SDK to have case-sensitive passwords.

The following table lists the platforms on which case-sensitive password feature is supported:

Feature	NetWare	Linux	UNIX	Windows
Enforcing case-sensitive Universal Password	✓	✓	✓	✓

NOTE: For this release, if you do not upgrade eDirectory on Netware to eDirectory 8.8, you will not be able to have case-sensitive passwords for iManager login even though you upgrade iManager to iManager 2.6.

This chapter includes the following information:

- ♦ [Section 5.1, “Need for Case-Sensitive Passwords,” on page 39](#)
- ♦ [Section 5.2, “How to Make Your Password Case-Sensitive,” on page 40](#)
- ♦ [Section 5.3, “Upgrading the Legacy Novell Clients and Utilities,” on page 41](#)
- ♦ [Section 5.4, “Preventing Legacy Novell Clients from Accessing eDirectory 8.8 Server,” on page 42](#)

5.1 Need for Case-Sensitive Passwords

Making the passwords case-sensitive adds to the security of the login to the directory. For example, if you have a password aBc that is case-sensitive, all the trials of login with the combinations like abc or Abc or ABC would fail.

In eDirectory 8.7.1 and 8.7.3, when you enabled [Universal Password](http://www.novell.com/documentation/nmas23/admin/data/allq21t.html) (<http://www.novell.com/documentation/nmas23/admin/data/allq21t.html>), the password was case-sensitive only when you logged in through Novell Client32™. The password was not case-sensitive when you logged in through other clients (for example, eDirectory SDK or iManager).

Now, in eDirectory 8.8 and later, you can make your passwords case-sensitive for all the clients that are upgraded to eDirectory 8.8.

By enforcing the use of case-sensitive passwords, you can prevent the legacy Novell clients from accessing the eDirectory 8.8 server. Refer to [Section 5.4, “Preventing Legacy Novell Clients from Accessing eDirectory 8.8 Server,” on page 42](#) for more information.

5.2 How to Make Your Password Case-Sensitive

In eDirectory 8.8 and later, you can make your passwords case-sensitive for all the clients by enabling Universal Password. Universal Password is disabled by default.

5.2.1 Prerequisites

By default LDAP and other server-side utilities use NDS login first and if this fails, use the Simple Password login. For the case-sensitive password feature to work, the login needs to happen through NMAS. Therefore, you need to set the environment variable `NDSD_TRY_NMASLOGIN_FIRST` to true. This makes the case-sensitive password feature available.

Complete the following procedure to make the case-sensitive password feature available:

1 Set the environment variable

- ◆ Linux and UNIX:

Add the following in the `ndsd` script `/etc/init.d/ndsd` before `StartNdsd()` function:

```
NDSD_TRY_NMASLOGIN_FIRST=true
export NDSD_TRY_NMASLOGIN_FIRST
```

- ◆ NetWare:

Add the following in the beginning of `c:\nwserver\startup.ncf` file:

```
env NDSD_TRY_NMASLOGIN_FIRST=true
```

- ◆ Windows:

Right-click My Computer and select Properties. In the Advanced tab click Environment Variables. Under System Variables, add the variable and set the value to true.

- ◆ AIX:

Add the following in the `ndsd` script `/etc/init.d/ndsd` before `StartNdsd()` function:

```
NDSD_TRY_NMASLOGIN_FIRST=true
export NDSD_TRY_NMASLOGIN_FIRST
```

2 Restart the eDirectory server.

5.2.2 Making Your Password Case-Sensitive

1 Log in to eDirectory using the existing password.

In the case of fresh install, the existing password is the one that you set while configuring eDirectory 8.8.

For example, your password is “novell”.

NOTE: This password is not case-sensitive.

2 Enable Universal Password.

For more information, refer to the *Deploying Universal Password* (<http://www.novell.com/documentation/nmas23/admin/data/allq21t.html>).

- 3 Log out of eDirectory.
- 4 Log in to eDirectory using the existing password with the case you want.

The password you give now will be case-sensitive.

For example, you enter “NoVELL”.

Your password is now “NoVELL”. Therefore, “novell” or any alternate capitalization combination other than “NoVELL” would be invalid.

If you are migrating to case-sensitive passwords, refer to [Section 5.3.1, “Migrating to Case-Sensitive Passwords,” on page 41](#).

Any new password you set will be case-sensitive depending on which level (object or partition) you have enabled Universal Password.

5.2.3 Managing Case-Sensitive Passwords

You can manage the case sensitivity of your passwords by enabling or disabling Universal Password through Novell iManager. For more information, refer to the [Deploying Universal Password \(http://www.novell.com/documentation/nmas23/admin/data/allq21t.html\)](http://www.novell.com/documentation/nmas23/admin/data/allq21t.html).

5.3 Upgrading the Legacy Novell Clients and Utilities

The following are the latest versions of the Novell clients and utilities:

- ♦ Novell Client 4.9
- ♦ Administration utilities with eDirectory 8.8
- ♦ Novell iManager 2.6 and later

The clients and utilities that are earlier than the above mentioned versions are legacy Novell clients.

You can have case-sensitive passwords for the legacy Novell clients after upgrading them to their latest versions. eDirectory 8.8 makes the migration from your existing passwords to case-sensitive passwords easy and flexible. Refer to [Section 5.3.1, “Migrating to Case-Sensitive Passwords,” on page 41](#) for more information.

In case you do not upgrade the legacy clients to their latest versions, these clients can be blocked from using eDirectory 8.8 at the server level. Refer to [Section 5.4, “Preventing Legacy Novell Clients from Accessing eDirectory 8.8 Server,” on page 42](#) for more information.

5.3.1 Migrating to Case-Sensitive Passwords

Universal Password is disabled by default and, therefore, your existing passwords will not be affected until you enable Universal Password in iManager. For step-by-step instruction, refer to [Section 5.2, “How to Make Your Password Case-Sensitive,” on page 40](#).

The following example explains the migration to case-sensitive passwords:

Login session 1: Universal Password is disabled by default.

- ♦ You log in using your existing password. For example, suppose your password is novell.

- ♦ This password is not case-sensitive. Therefore, both novell and Novell are valid passwords.
- ♦ After you log in, you enable Universal Password. Refer to *Deploying Universal Password* (<http://www.novell.com/documentation/nmas23/admin/data/allq21t.html>).

Login session 2: Universal Password was enabled in the previous session.

- ♦ You log in using your existing password. For example, suppose you type the password as noVell.
- ♦ When Universal Password is enabled, this password becomes case-sensitive. So you must remember how you typed the password this time.

Login session 3 and subsequent logins.

- ♦ If you log in using the password noVell, it is valid.
- ♦ If you log in using the password Novell (or any other version except noVell), it is invalid.

5.4 Preventing Legacy Novell Clients from Accessing eDirectory 8.8 Server

In eDirectory 8.7.1 and 8.7.3, you were able to prevent the legacy Novell clients from **setting or changing** the NDS[®] password. With eDirectory 8.8, you can also prevent them from logging in to eDirectory 8.8 and verifying the passwords.

To allow or disallow the legacy Novell clients from using eDirectory 8.8, you need to configure NDS login either through iManager or LDAP.

This section includes the following information:

- ♦ [Section 5.4.1, “Need for Preventing Legacy Novell Clients from Accessing eDirectory 8.8 Server,” on page 42](#)
- ♦ [Section 5.4.2, “Managing NDS Login Configurations,” on page 43](#)
- ♦ [Section 5.4.3, “Partition Operations,” on page 46](#)
- ♦ [Section 5.4.4, “Enforcing Case-Sensitive Passwords in a Mixed Tree,” on page 47](#)

5.4.1 Need for Preventing Legacy Novell Clients from Accessing eDirectory 8.8 Server

The passwords of the legacy Novell clients are not case-sensitive. Therefore, in eDirectory 8.8 and later, when you want to enforce the use of case-sensitive passwords, you might need to block the legacy clients from accessing the directory.

In versions earlier than Novell Client 4.9, Universal Password was not supported. This was because login and password changes went straight to NDS password instead of to NMAS. Now, if you are using Universal Password, changing passwords through legacy clients can create a problem called “password drift”. This means that the NDS password and Universal Password are not synchronized. To prevent this issue, one option is to block password changes from clients earlier than version 4.9.

Refer to the next section, [Managing NDS Login Configurations](#), for more information on how to block the legacy clients from accessing eDirectory 8.8 eDirectory 8.8 server.

5.4.2 Managing NDS Login Configurations

By configuring the NDS login, you can allow or disallow the legacy Novell clients from accessing the eDirectory 8.8 server. You can manage NDS login configurations through Novell iManager 2.6 and LDAP.

In eDirectory 8.8 and later, you can configure the setting and changing of passwords through LDAP as well as iManager.

This section includes information on the following:

- ◆ “NDS Configurations at Different Levels” on page 43
- ◆ “Managing NDS Configurations Through iManager” on page 44
- ◆ “Managing NDS Configurations Through LDAP” on page 45
- ◆ Section 5.4.4, “Enforcing Case-Sensitive Passwords in a Mixed Tree,” on page 47

NDS Configurations at Different Levels

You can configure NDS login at one or all the following levels:

- ◆ Partition level
- ◆ Object level

If you do not specify the configuration at any of the levels, NDS login configuration is enabled at all the levels.

The object level configuration always overrides the partition level configuration. This is described in the following table:

Table 5-1 NDS Configuration

Configuration at Object Level	Configuration at Partition Level	Configuration
Not Specified	Enabled	Enabled
Enabled	Not Specified	Enabled
Not Specified	Disabled	Disabled
Disabled	Not Specified	Disabled
Enabled	Enabled	Enabled
Enabled	Disabled	Enabled
Disabled	Enabled	Disabled
Disabled	Disabled	Disabled

At all the levels (object and partition) you can configure NDS login for the following:

- ◆ Logging in to the directory using an NDS password or verifying the NDS password
- ◆ Setting a new password and changing the existing password

Logging In to the Directory or Verifying the NDS Password

Login/verify NDS password means:

- ◆ Logging in to the directory using an NDS password.
- ◆ Verifying the existing password in the directory.

Login/verify NDS password is enabled by default. When you disable the login/verify key, you will not be able to log in to the latest version of eDirectory or verify the passwords. You can enable or disable login/verify NDS password at partition and object levels. If login/verify is disabled, you will not be able to [set or change NDS passwords](#).

You can configure login/verify NDS password through iManager and LDAP. For more information, refer to [“Managing NDS Configurations Through iManager” on page 44](#) and [“Managing NDS Configurations Through LDAP” on page 45](#).

Setting a New Password or Changing the NDS Password

Set/change an NDS password means

- ◆ Setting a new password for an object.
- ◆ Changing the existing password for an object.

Set/change NDS password is enabled by default. When you disable the set/change key, you will not be able to set a new password or change the existing password in eDirectory. You can enable or disable set/change NDS password at partition and object levels. If login/verify is disabled, you will not be able to set/change passwords.

Earlier you were able to set/change of NDS passwords through LDAP only. Now you can do it through iManager also. For more information, refer to [“Managing NDS Configurations Through iManager” on page 44](#) and [“Managing NDS Configurations Through LDAP” on page 45](#).

Managing NDS Configurations Through iManager

This section includes the following information:

- ◆ [“Enabling/Disabling NDS Configuration for a Partition” on page 44](#)
- ◆ [“Enabling/Disabling NDS Configuration for an Object” on page 45](#)

You can turn on the [login/verify key](#) or [set/change key](#) in NDS login configuration.

Enabling/Disabling NDS Configuration for a Partition

To enable NDS login for pre-eDirectory 8.8 clients:

- 1 In Novell iManager, click the *Roles and Tasks* button [Description: Roles and Tasks Button](#) .
- 2 Select *NMAS > Universal Password Enforcement*.
- 3 In the Universal Password Enforcement plug-in, select *NDS Configuration for a Partition*.
- 4 Follow the instructions in the NDS Configuration for a Partition wizard to configure the login and password management at a partition level.

Help is available throughout the wizard.

Enabling/Disabling NDS Configuration for an Object

To enable NDS login for pre-eDirectory 8.8 clients:

- 1 In Novell iManager, click the *Roles and Tasks* button [Description: Roles and Tasks Button](#) .
 - 2 Select *NMAS > Universal Password Enforcement*.
 - 3 In the wizard, select *NDS Configuration for an Object*.
 - 4 Follow the instructions in the NDS Configuration for an Object wizard to configure the login and password management at an object level.
- Help is available throughout the wizard.

Managing NDS Configurations Through LDAP

IMPORTANT: We strongly recommend you to use iManager for managing NDS configurations and not LDAP.

You can manage NDS configurations through LDAP using an eDirectory attribute on a partition root container or object. The attributes are a part of the schema in eDirectory 8.7.1 or later, and are not supported on eDirectory 8.7 or earlier.

The method used by legacy clients to configure the NDS login configurations is called NDAP login management and the method used for NDS password configurations is called NDAP password management.

This section provides information on:

- ♦ “[Enabling/Disabling NDS Configuration for a Partition](#)” on page 45
- ♦ “[Enabling/Disabling NDS Configurations for an Object](#)” on page 46

Enabling/Disabling NDS Configuration for a Partition

Login and Verify Password Management

Use the `ndapPartitionLoginMgmt` attribute to enable or disable NDS login and verify password management for a partition.

<code>ndapPartitionLoginMgmt</code> Attribute Value	Description
Not present or not specified	NDAP login management is enabled.
0	NDAP login management is disabled.
1	NDAP login management is enabled.

Set and Change NDS Password

Use the `ndapPartitionPasswordMgmt` attribute to enable or disable the setting and changing of an NDS password for a partition.

<code>ndapPartitionPasswordMgmt</code> Attribute Value	Description
Not present or not specified	NDAP password management is enabled.

ndapPartitionPasswordMgmt Attribute Value	Description
0	NDAP password management is disabled.
1	NDAP password management is enabled.

Enabling/Disabling NDS Configurations for an Object

Login and Verify NDS Password

Use the ndapLoginMgmt attribute to enable or disable NDS login and verify management for an object.

ndapLoginMgmt Attribute Value	Description
Not present or not specified	NDAP login management depends on the configuration at the partition level.
0	NDAP login management is disabled if it is disabled at the partition level.
1	NDAP login management is enabled irrespective of the configuration setting at the partition level.

Set and Change NDS Password

Use the ndapPasswordMgmt attribute to enable or disable the setting and changing of an NDS password for an object.

ndapPasswordMgmt Attribute Value	Description
Not present or not specified	NDAP password management depends on the configuration at the partition level.
0	NDAP password management is disabled if it is disabled at the partition level.
1	NDAP password management is enabled irrespective of the configuration setting at the partition level.

NOTE: For more information on creating and managing priority sync policies, refer to *Using LDAP Tools on Linux, Solaris, or AIX* (<http://www.novell.com/documentation/edir88/>) and *Novell Import Conversion Export Utility* (<http://www.novell.com/documentation/edir88/>).

5.4.3 Partition Operations

When you split a partition, the NDS configurations are not inherited by the child partition. When you merge partitions, the NDS configurations of the parent are retained by the resultant partition.

5.4.4 Enforcing Case-Sensitive Passwords in a Mixed Tree

If a tree exists with an eDirectory 8.8 or later server and an eDirectory 8.7 or earlier server, and the two servers share a partition, disabling NDS login configuration on that partition will have unreliable results. The 8.8 server will enforce the setting, preventing legacy clients from accessing the directory. However, the 8.7 server will not enforce the setting, so you can access the directory through the 8.7 server.

5.5 For More Information

Refer to the following for more information on case-sensitive passwords:

- ♦ iManager online help
- ♦ *Deploying Universal Password* (<http://www.novell.com/documentation/nmas23/admin/data/allq21t.html>)

Priority Sync

Priority Sync is a new feature in Novell® eDirectory 8.8™ that is complimentary to the current synchronization process in eDirectory. Through Priority Sync, you can synchronize the modified critical data, such as passwords, immediately.

You can sync your critical data through Priority Sync when you cannot wait for normal synchronization. The Priority Sync process is faster than the normal synchronization process. Priority Sync is supported only between two or more eDirectory 8.8 or later servers hosting the same partition.

The following table lists the platforms that support the Priority Sync feature:

Feature List	NetWare	Linux	UNIX	Windows
Priority Sync	✓	✓	✓	✓

This chapter includes the following information:

- ♦ [Section 6.1, “Need for Priority Sync,” on page 49](#)
- ♦ [Section 6.2, “Using Priority Sync,” on page 50](#)

6.1 Need for Priority Sync

Normal synchronization can take some time, during which the modified data would not be available on other servers. For example, suppose that in your setup you have different applications talking to the directory. You change your password on Server1. With normal synchronization, it is some time before this change is synchronized with Server2. Therefore, a user would still be able to authenticate to the directory through an application talking to Server2, using the old password.

Figure 6-1 Need for Priority Sync

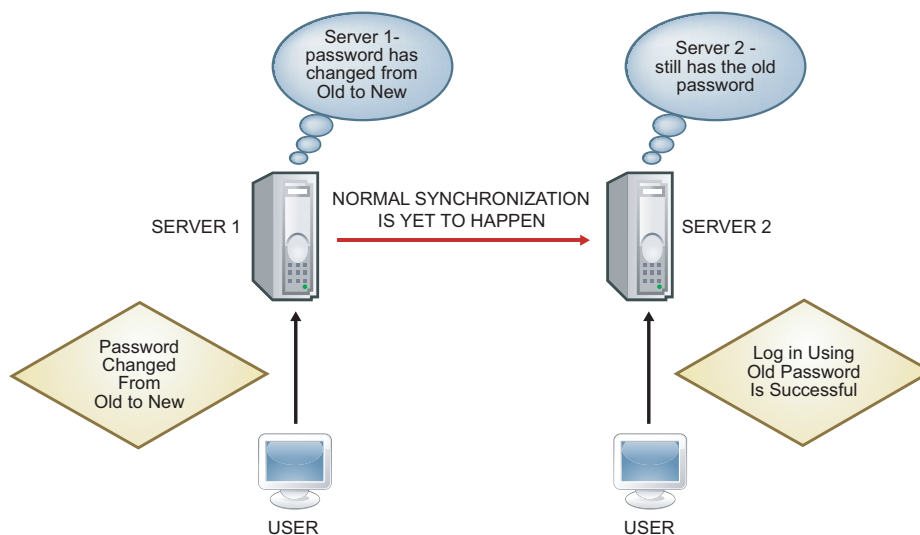

In large deployments, when the critical data of an object is modified, changes need to be synchronized immediately. The Priority Sync process resolves this issue.

6.2 Using Priority Sync

To synchronize data modifications through Priority Sync, you need to do the following:

1. Enable Priority Sync, configure the number of threads, and Priority Sync the queue size through Novell iMonitor.
2. Define Priority Sync policies by identifying the attributes that are critical through iManager.
3. Apply the Priority Sync policies to the partitions through iManager.

6.3 For More Information

Refer to the following for more information on Priority Sync:

- ♦ *Novell eDirectory 8.8 Administration Guide* (<http://www.novell.com/documentation/edir88/edir88/data/brp2di9.html#brp2z9z>)
- ♦ iManager and iMonitor online help

Data Encryption

7

In Novell® eDirectory™ 8.8 and later, you can encrypt specific data when they are stored on the disk and when they are transmitted between two or more eDirectory 8.8 servers. This provides greater security for the confidential data.

The following table lists the platforms that support the data encryption feature:

Feature	NetWare	Linux	UNIX	Windows
Encrypted Attributes	✓	✓	✓	✓
Encrypted Replication	✗	✓	✓	✓

This chapter includes the following information:

- ♦ [Section 7.1, “Encrypting Attributes,” on page 51](#)
- ♦ [Section 7.2, “Encrypting Replication,” on page 52](#)

7.1 Encrypting Attributes

eDirectory 8.8 enables you to encrypt sensitive data stored in the disk. Encrypted attributes is a server-specific feature.

You can access encrypted attributes only over secure channels unless you choose to provide access over clear text channels too. Refer to [Section 7.1.3, “Accessing the Encrypted Attributes,” on page 52](#) for more information.

This section includes the following information:

- ♦ [Section 7.1.1, “Need for Encrypted Attributes,” on page 51](#)
- ♦ [Section 7.1.2, “How to Encrypt Attributes,” on page 52](#)
- ♦ [Section 7.1.3, “Accessing the Encrypted Attributes,” on page 52](#)

The encrypted attributes feature is supported only on eDirectory 8.8 and later servers.

7.1.1 Need for Encrypted Attributes

Prior to eDirectory 8.8, data was stored in clear text on the disk. There was a need to protect the data and provide access to the data only over secure channels.

You can use this feature in scenarios where you need to protect confidential data such as credit card numbers of bank customers.

7.1.2 How to Encrypt Attributes

You can encrypt attributes by creating and defining encrypted attributes policies and then applying these policies to the servers. You can create, define, apply, and manage encrypted attributes policies through iManager and LDAP.

- 1 Create and define an encrypted attribute policy:
 - 1a Determine the attributes for encryption.
 - 1b Determine the encryption scheme for the attributes.
- 2 Apply the encrypted attributes policy to a server.

7.1.3 Accessing the Encrypted Attributes

You can access the encrypted attributes only over secure channels like the LDAP SSL port or the HTTP secure port. You can choose to provide access to the encrypted attributes through clear text channels using the iManager plug-in. For more information, refer to the *Novell eDirectory 8.8 Administration Guide* (<http://www.novell.com/documentation/edir88/index.html>).

7.2 Encrypting Replication

Encrypted replication refer to encrypting data that is transmitted between two or more eDirectory 8.8 servers.

Encrypted replication is complimentary to the normal synchronization in eDirectory.

This section includes the following information:

- ♦ [Section 7.2.1, “Need for Encrypted Replication,” on page 52](#)
- ♦ [Section 7.2.2, “Enabling Encrypted Replication,” on page 53](#)

NOTE: The encrypted replication feature is not supported on Netware®.

7.2.1 Need for Encrypted Replication

Prior to eDirectory 8.8, data was transmitted through the wire during replication in clear text. There was a need to protect confidential data over the wire by encrypting it, especially if the replicas were separated geographically and connected through the Internet.

This feature can be used in the following scenarios:

- ♦ If the directory servers are spread across geographical locations through WAN and the Internet and there is a need to encrypt sensitive data on wire.
- ♦ If you want only some partitions of your tree to be protected, you can selectively indicate the partitions holding the sensitive data to be encrypted for replication.
- ♦ If you require encrypted replication between specific replicas of a partition that contain sensitive data.
- ♦ If you feel the network in your setup is hostile, you might want to protect sensitive data during replication.

7.2.2 Enabling Encrypted Replication

You can enable encrypted replication using iManager. You can enable encrypted replication at the partition level and replica level.

IMPORTANT: Before enabling encrypted replication, ensure that both source and destination servers have the default certificates. If you have made any changes to the certificates, like renaming them, encrypted replication fails.

7.3 For More Information

Refer to the following for more information on encrypting data in eDirectory:

- ♦ *Novell eDirectory 8.8 Administration Guide* (<http://www.novell.com/documentation/edir88/index.html>)
- ♦ iManager and iMonitor online help

Bulkload Performance

8

Novell® eDirectory™ 8.8 provides you with enhancements to increase bulkload performance.

For information on increasing the bulkload performance, refer to the following sections of the *Novell eDirectory 8.8 Administration Guide*:

- ◆ eDirectory Cache Settings
- ◆ LBURP Transaction Size Setting
- ◆ Increasing the Number of Asynchronous Requests in ICE
- ◆ Increased Number of LDAP Writer Threads
- ◆ Disabling Schema Validation in ICE
- ◆ Disabling ACL Templates
- ◆ Backlinker
- ◆ Enabling/Disabling Inline Cache
- ◆ Increasing the LBURP Time Out Period
- ◆ Offline Bulkload Using ldif2dib

iManager ICE Plug-ins

9

Prior to Novell® eDirectory™ 8.8, some of the Novell Import Conversion Export (ICE) utility command line options did not have corresponding options in the iManager plug-in.

The following table lists the platforms that support this feature:

Feature	NetWare	Linux	UNIX	Windows
ICE iManager enhancements	✓	✓	✓	✓

The ICE wizard in iManager 2.6 with eDirectory 8.8 provides the following features:

- ♦ Add missing schema
- ♦ Compare schema
- ♦ Generate an order file

9.1 Adding Missing Schema

In eDirectory 8.8, iManager provides you with options for adding missing schema to a server's schema. This process involves comparing a source and a destination. If there is additional schema in the source schema, this is added to the destination schema. The source can be either a file or an LDAP server; the destination should be an LDAP server.

Through the ICE wizard in iManager, you can add the missing schema using the following options:

- ♦ Add Schema from a File
- ♦ Add Schema from a Server

9.1.1 Add Schema from a File

ICE can compare the schema in the source and destination. The source is a file or LDAP Server, and the destination is an LDAP server. The source schema file can be in either the LDIF or SCH format.

Figure 9-1 Compare and Add the Schema from a File

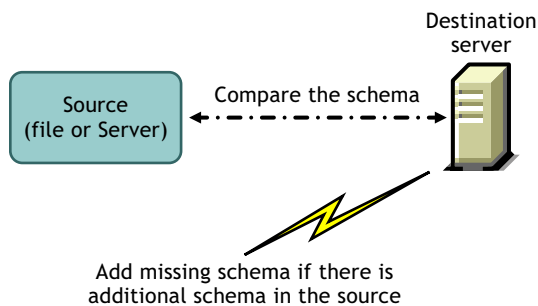

If you want to only compare the schema and not add the additional schema to the destination server, select the *Do Not Add but Compare* option. In this case, the additional schema is not added to the destination server but the differences between the schema are available to you as a link at the end of the operation.

Figure 9-2 Compare Schema and Add the Results to an Output File

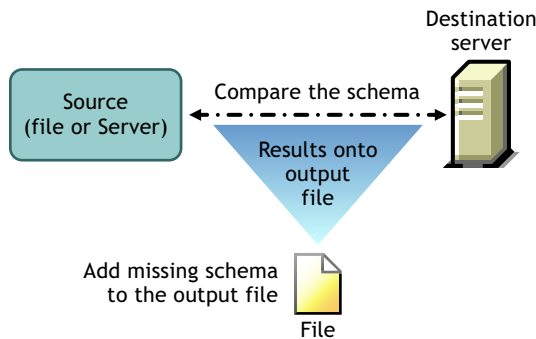

For more information, refer to the [Novell eDirectory Management Utilities \(http://www.novell.com/documentation/edir88/edir88/data/a5hf8rg.html#a5hf8rg\)](http://www.novell.com/documentation/edir88/edir88/data/a5hf8rg.html#a5hf8rg) chapter in the *Novell eDirectory 8.8 Administration Guide*.

9.1.2 Add Schema from a Server

The source and destination are LDAP servers.

If you want to only compare the schema and not add the additional schema to the destination server, select the *Do Not Add but Compare* option. In this case, the additional schema is not added to the destination server, but the differences between the schema are available to you as a link at the end of the operation.

For more information, refer to the [Novell eDirectory Management Utilities \(http://www.novell.com/documentation/edir88/edir88/data/a5hf8rg.html#a5hf8rg\)](http://www.novell.com/documentation/edir88/edir88/data/a5hf8rg.html#a5hf8rg) chapter in the *Novell eDirectory 8.8 Administration Guide*.

9.2 Comparing the Schema

Using iManager, you can compare the schema between a source and a destination. The source can be either a file or a server; the destination should be an LDIF file.

iManager compares the schema between a source and a destination and then stores the results in an output file.

Through the ICE wizard in iManager, you can compare the schema using the following options:

- ◆ Compare Schema Files
- ◆ Compare Schema between a Server and a File

9.2.1 Compare Schema Files

The *Compare Schema Files* option compares the schema between a source file and a destination file and then places the result in an output file. To add the missing schema to the destination file, apply the records of the output file to the destination file.

For more information, refer to the [Novell eDirectory Management Utilities \(http://www.novell.com/documentation/edir88/edir88/data/a5hf8rg.html#a5hf8rg\)](http://www.novell.com/documentation/edir88/edir88/data/a5hf8rg.html#a5hf8rg) chapter in the *Novell eDirectory 8.8 Administration Guide*.

9.2.2 Compare Schema between a Server and a File

The *Compare Schema between a Server and a File* option compares the schema between a source server and a destination file and then places the result in an output file. To add the missing schema to the destination file, apply the records of the output file to the destination file.

For more information, refer to the [Novell eDirectory Management Utilities \(http://www.novell.com/documentation/edir88/edir88/data/a5hf8rg.html#a5hf8rg\)](http://www.novell.com/documentation/edir88/edir88/data/a5hf8rg.html#a5hf8rg) chapter in the *Novell eDirectory 8.8 Administration Guide*.

9.3 Generating an Order File

This option creates an order file for use with the delim handler to import data from a delimited data file. The wizard helps you to create this order file that contains a list of attributes for a specific object class.

For more information, refer to the [Novell eDirectory Management Utilities \(http://www.novell.com/documentation/edir88/edir88/data/a5hf8rg.html#a5hf8rg\)](http://www.novell.com/documentation/edir88/edir88/data/a5hf8rg.html#a5hf8rg) chapter in the *Novell eDirectory 8.8 Administration Guide*.

9.4 For More Information

For more information on this feature, refer to the following:

- ♦ [Novell eDirectory 8.8 Administration Guide \(http://www.novell.com/documentation/edir88/edir88/data/agwkqyb.html#agwkqyb\)](http://www.novell.com/documentation/edir88/edir88/data/agwkqyb.html#agwkqyb).
- ♦ iMonitor online help.

LDAP-Based Backup

10

The LDAP-based backup feature is introduced with Novell® eDirectory™ 8.8. This feature is used to backup the attributes and attribute values one object at a time.

The following table lists the platforms that support this feature:

Feature	NetWare	Linux	UNIX	Windows
LDAP based-backup	✓	✓	✓	✓

This feature lets you perform an incremental backup wherein the object is backed up only if there are changes to the object.

LDAP-based backup provides a set of interfaces for backup and restore of eDirectory objects exposed through the LDAP Libraries for C through LDAP extended operations.

For more information on LDAP Libraries for C SDK, refer to [LDAP Libraries for C documentation](http://developer.novell.com/ndk/doc/cldap/ldaplibc/data/hevgtl7k.html). (<http://developer.novell.com/ndk/doc/cldap/ldaplibc/data/hevgtl7k.html>).

For an example of how to do backup and restore of eDirectory objects through LDAP, refer to the [backup.c sample code](http://developer.novell.com/ndk/doc/samplecode/cldap_sample/extensions/backup.c.html) (http://developer.novell.com/ndk/doc/samplecode/cldap_sample/extensions/backup.c.html).

10.1 Need for LDAP Based Backup

The LDAP based backup tries to resolve the problems with the current backup and restore.

The problems that this feature resolves are:

- ◆ Gives a consistent interface using which any third party backup applications or developers can backup eDirectory on all the supported platforms.
- ◆ Provides a backup solution to backup objects incrementally.

10.2 For More Information

For more information on this feature, refer to the following:

- ◆ [LDAP Libraries for C](http://developer.novell.com/ndk/cldap.htm) (<http://developer.novell.com/ndk/cldap.htm>)
- ◆ Sample code: [backup.c](http://developer.novell.com/ndk/doc/samplecode/cldap_sample/extensions/backup.c.html) (http://developer.novell.com/ndk/doc/samplecode/cldap_sample/extensions/backup.c.html)

Managing Error Logging in eDirectory 8.8

11

Many customers have reported that the error logging in Novell® eDirectory™ does not help much in identifying and resolving the common problems. Error logging is automatically started during eDirectory installation.

This chapter consists of the following sections:

- ♦ [Section 11.1, “Message Severity Levels,” on page 63](#)
- ♦ [Section 11.2, “Configuring Error Logging,” on page 64](#)
- ♦ [Section 11.3, “DSTrace Messages,” on page 68](#)
- ♦ [Section 11.4, “iMonitor Message Filtering,” on page 71](#)
- ♦ [Section 11.5, “SAL Message Filtering,” on page 72](#)

11.1 Message Severity Levels

All the messages have a severity level attached to it that helps you determine how critical the message is. The levels in decreasing order of severity are:

- ♦ [Section 11.1.1, “Fatal,” on page 63](#)
- ♦ [Section 11.1.2, “Warning,” on page 63](#)
- ♦ [Section 11.1.3, “Error,” on page 64](#)
- ♦ [Section 11.1.4, “Information,” on page 64](#)
- ♦ [Section 11.1.5, “Debug,” on page 64](#)

11.1.1 Fatal

A fatal message indicates a significant problem, such as loss of data or functionality.

Examples:

- ♦ If the eDirectory server fails to load system modules like NCP Engine and DS Loader while loading modules, a fatal error is reported and logged.
- ♦ If the eDirectory server fails to bind on secure port 636, then a fatal error is reported and logged.

11.1.2 Warning

A message that is not necessarily severe, but might be a possible cause for future problem.

Examples:

- ♦ Connection failures between any two servers in tree, resulting in server getting added to bad address cache. Server can recover from this particular state by resetting the bad address cache.

- ♦ If the LDAP client application does a bind and closes the connection without doing an unbind then LDAP server should log warning with appropriate warning message.
- ♦ If the eDirectory server has consumed all the file descriptors and it has reached the Threshold limit as result server is not able to process any incoming requests and respond it and leading to failure of the application.

11.1.3 Error

A message that could be due to invalid operation, but which will not cause any problem.

Examples:

- ♦ When an client application tries to add a object for which attributes definition are not defined In schema, then eDirectory server will report the ERR_NO_SUCH_ATTRIBUTE error.
- ♦ When an User tries to login with an invalid password, eDirectory server will report error ERR_FAILED_AUTHENTICATION.

11.1.4 Information

A message that describes successful completion of an operation or event in the eDirectory server.

Examples:

- ♦ When a module gets loaded/unloaded successfully, it may be appropriate to log an informative message of the operation.
- ♦ When database cache configuration is changed, informative message should be logged on successfully saving the configuration.

11.1.5 Debug

A message that contains information which will help developers in debugging a program.

Examples:

While doing a dynamic group search, display all the dynamic group members with information of entry ID, partition ID, and DN of the members. This information will help in knowing that all members are returned at the eDirectory level.

11.2 Configuring Error Logging

- ♦ [Section 11.2.1, “Linux and UNIX,” on page 64](#)
- ♦ [Section 11.2.2, “Windows,” on page 65](#)
- ♦ [Section 11.2.3, “NetWare,” on page 67](#)

11.2.1 Linux and UNIX

To configure the error logging settings for the server-side messages, you can use the `n4u.server.log-levels` and `n4u.server.log-file` parameters in the `/etc/opt/novell/eDirectory/conf/nds.conf` configuration file.

Setting the Severity Level

The severity levels available are LogFatal, LogWarn, LogErr, LogInfo, and LogDbg levels (in decreasing order of severity). For more information on the severity levels, refer to [Section 11.1, “Message Severity Levels,”](#) on page 63.

By default, the severity level is set "LogFatal". So, only messages with severity level fatal will be logged.

To set the severity level, use the `n4u.server.log-levels` parameter in the `nds.conf` file as follows:

```
n4u.server.log-levels=severity_level
```

For example:

- ♦ To set the severity level to LogInfo and above, type the following:

```
n4u.server.log-levels=LogInfo
```

With this configuration, messages with severity level LogInfo and above (that is, LogFatal, LogWarn, and LogErr) will be logged into log file.

- ♦ To set the severity level to LogWarn and above, type the following:

```
n4u.server.log-levels=LogWarn
```

With this configuration, messages with severity level LogWarn and above (LogFatal) will be logged into the log file.

Specifying the Log File Name

To specify the location of the log file where the messages will be logged, use the `n4u.server.log-file` parameter in the `nds.conf` file. By default, the messages are logged into the `nds.log` file.

For example, to log the messages to `/tmp/edir.log`, type in the following:

```
n4u.server.log-file=/tmp/edir.log
```

To log the messages in the system log, use the `n4u.server.log-file` parameter as follows:

```
n4u.server.log-file=syslog
```

Specifying the Log File Size

To specify the size of the log file, use the `n4u.server.log-file-size` parameter in the `nds.conf` file. The maximum file limit can be 2 GB and the default file size is 1 MB. However, you can set the file size to below 1 MB also.

This setting is not applicable to the `nds.log` file.

If the log file size reaches the specified limit, then logger overwrites the log file from the start.

11.2.2 Windows

- ♦ [“Setting the Severity Level”](#) on page 66
- ♦ [“Specifying the Log File Name and Path”](#) on page 66
- ♦ [“Specifying the Log File Size”](#) on page 66

Setting the Severity Level

The severity levels available are LogFatal, LogWarn, LogErr, LogInfo, and LogDbg levels (in decreasing order of severity). For more information on the severity levels, refer to [Section 11.1, “Message Severity Levels,”](#) on page 63.

To set the severity level, do the following:

- 1 Click *Start > Settings > Control Panel > Novell eDirectory Services*
- 2 In the *Services* tab, select *dhlog.dlm*.
- 3 Enter the log level in the *Startup Parameters* box.

For example, to set the log level to LogErr and above, enter the following:

```
LogLevel=LogErr
```

- 4 Click *Configure*
- 5 In the *ACS Config* tab, click the plus sign of *DHostLogger*.
The LogLevel parameter is updated with the configured value.

Specifying the Log File Name and Path

- 1 Click *Start > Settings > Control Panel > Novell eDirectory Services*
- 2 In the *Services* tab, select *dhlog.dlm*.
- 3 Enter the log file path in *Startup Parameters* as follows:

```
LogFile=file_path
```

For example, to set the log file path to /tmp/Err.log, enter the following in startup parameters:

```
LogFile=/tmp/Err.log
```

- 4 Click *Configure*
- 5 In the *ACS Config* tab, click the plus sign of *DHostLogger*.
The LogFile parameter is updated with the configured value.

Specifying the Log File Size

- 1 Click *Start > Settings > Control Panel > Novell eDirectory Services*
- 2 In the *Services* tab, select *dhlog.dlm*.
- 3 Enter the log file path in *Startup Parameters* as follows:

```
LogSize=size
```

The default file size is 1 MB.

- 4 Click *Configure*
- 5 In the *ACS Config* tab, click the plus sign of *DHostLogger*.
The LogSize parameter is updated with the configured value.

11.2.3 NetWare

On NetWare, the DSLOG.NLM logs server-side messages. The server-side messages are logged to `sys:\system\ds.log`.

NOTE: DSLOG.NLM is automatically up when DS is up. However, you can manually unload/load DSLOG.NLM.

The severity levels available are LogFatal, LogWarn, LogErr, LogInfo, and LogDbg levels (in decreasing order of severity). For more information on the severity levels, refer to [Section 11.1, “Message Severity Levels,”](#) on page 63.

By default, the events tags and messages are logged in `ds.log`. The messages are logged in the following format:

```
<event tag>: <time>: <severity level>: message
```

For example:

```
INIT: [2005/03/25 15:27:14] INFO: NDS Schema Upgrade Version: DIB 1, Code 1
PART: [2005/03/25 16:18:10] DEBUG: Merging partition root data during partition
join success
```

Configuring the Filters

To configure the filters, enter the following syntax:

```
DSLOG options
```

The following table explains the `dslog` options:

Table 11-1 *Dslog Option Description*

Option	Description
FILE ON	Enable logging to log file. By default, FILE is set to ON.
FILE OFF	Disable logging to log file.
FMAX= <i>size</i>	Specify maximum disk file size.
SLEVEL= <i>value</i>	Specify error severity level. By default, SLEVEL is set to LogFatal.
FNAME= <i>name</i>	Specify disk file name. By default the file name is <code>ds.log</code> .

For example:

- ◆ To enable logging, enter the following:

```
DSLOG FILE ON
```

- ◆ To disable logging, enter the following:

```
DSLOG FILE OFF
```

- ◆ To set the maximum file size to 10240 bytes, enter the following:

```
DSLOG FMAX=10240
```

- ◆ To filter the debug messages and above, enter the following:

```
DSLOG SLEVEL=LOGDBG
```

- ◆ To specify the log file name, enter the following:

```
DSLOG FNAME=DS.LOG
```

For more information on the dslog option, see the online help. To do so, enter the following at the command prompt:

```
help dslog
```

Viewing the Current Configuration

You can use the GET option to view the current configuration settings as follows:

```
DSLOG GET
```

For example, if you've enabled DSLOG and set the severity level to debug, the output is similar to the following:

```
DSLOG Configuration:DSLOG File is ON      File Name: DS.LOGFile Size: nnnnn(Max:
nnnnn).          Severity Level: LOGDBG
```

11.3 DSTrace Messages

You can filter the trace messages based on the thread ID, connection ID, and severity of the messages.

Once you specify a filter for the messages, only the messages that fit the filter are displayed on the screen. All the other messages for the enabled tags will get logged into the `ndstrace.log` if the file is set to ON.

Only one filter is applicable at a time. Filter has to be specified for each session of `ndstrace`.

By default, the severity level is set to INFO, this means that all the messages with severity level more than INFO would be displayed. You can see the severity level by enabling the `svty` tag.

You can use `iMonitor` also to filter the trace messages. For more information, refer to [Section 11.4, "iMonitor Message Filtering,"](#) on page 71.

11.3.1 NetWare, Linux, and UNIX

Complete the following procedure to filter the trace messages:

NOTE: In the commands below, change `ndstrace` to `dstrace` on NetWare.

1 Enable filtering with the following command:

```
ndstrace tag filter_value
```

To disable filtering, enter the following command:

```
ndstrace tag
```

Examples for enabling filtering:

- ◆ To enable filtering for thread ID 35, enter the following:

```
ndstrace thrd 35
```

- ◆ To enable filtering for severity level fatal, enter the following:

```
ndstrace svty fatal
```

Severity levels can be FATAL, WARN, ERR, INFO, and DEBUG.

- ◆ To enable filtering for connection ID 21, enter the following:

```
ndstrace conn 21
```

Examples for disabling filtering:

- ◆ To disable filtering based on thread ID, enter the following:

```
ndstrace thrd
```

- ◆ To disable filtering based on connection ID, enter the following:

```
ndstrace conn
```

- ◆ To disable filtering based on severity, enter the following:

```
ndstrace svty
```

Figure 11-1 Sample Trace Message Screen With Filters

```
NCPEng : INFO      : NCP Reply to tcp:164.99.148.243, conn 14, task 0, seq 241, size 121, flags 0, ncperr
0.
NCPEng : INFO      : NCP Request from tcp:164.99.148.243, conn 22, task 0, seq 120, size 32, err 0.
NCPEng : INFO      : NCP: 104 (1) - Novell eDirectory Services (Novell eDirectory Ping).
NCPEng : INFO      : NCP Reply to tcp:164.99.148.243, conn 22, task 0, seq 120, size 54, flags 0, ncperr
0.
NCPEng : INFO      : NCP Request from tcp:164.99.148.243, conn 22, task 0, seq 121, size 248, err 0.
NCPEng : INFO      : NCP: 104 (2) - Novell eDirectory Services (Fragged Request).
Agent  : DEBUG     : Calling DSAResolveName conn:22 for client .[Public].
Reslv  : DEBUG     : ConvertDNToID: dn=\T=WIN-0510\0=novell\CN=OSG-NTS-2-NDS, cts=4281a5dc:01:001
NCPcli : DEBUG     : DCCreateContext context 3464002c moduleHandle 60000000 C:\Novell\NDS\ds.dlm, idHandle
00000000
Reslv  : DEBUG     : Connect to tcp:164.99.148.219:524 succeeded
DRL    : INFO      : Primary object is ID_INVALID
NCPcli : DEBUG     : DCFreeContext context 3464002c idHandle 00000000, connHandle 00001b00, C:\Novell\NDS
\ds.dlm
NCPEng : INFO      : NCP Reply to tcp:164.99.148.243, conn 22, task 0, seq 121, size 74, flags 0, ncperr
0.
NCPEng : INFO      : NCP Request from tcp:164.99.148.243, conn 14, task 0, seq 242, size 32, err 0.
NCPEng : INFO      : NCP: 104 (1) - Novell eDirectory Services (Novell eDirectory Ping).
NCPEng : INFO      : NCP Reply to tcp:164.99.148.243, conn 14, task 0, seq 242, size 46, flags 0, ncperr
0.
NCPEng : INFO      : NCP Request from tcp:164.99.148.243, conn 14, task 0, seq 243, size 196, err 0.
NCPEng : INFO      : NCP: 104 (2) - Novell eDirectory Services (Fragged Request).
Agent  : DEBUG     : Calling DSASStartUpdateReplica conn:14 for client .OSG-NTS-2-NDS.novell.WIN-0510.
Reslv  : DEBUG     : ConvertDNToID: dn=\T=WIN-0510, cts=4281a5dc:01:001
SyncI  : INFO      : ** SYNCHRONIZATION DISABLED! .WIN-0510., .OSG-NTS-2-NDS.novell.WIN-0510.
Agent  : DEBUG     : DSASStartUpdateReplica failed, synchronization disabled (-701).
NCPEng : INFO      : NCP Reply to tcp:164.99.148.243, conn 14, task 0, seq 243, size 32, flags 0, ncperr
0.
```

11.3.2 Windows

Complete the following procedure to filter the trace messages:

- 1 Select *Start > Control Panel > Novell eDirectory Services*
- 2 In the *Services* tab, select *dstrace.dlm*.
- 3 Click *Edit > Options* in the Trace window.

The Novell eDirectory Trace Options dialog box is displayed.

Figure 11-2 Trace Options Screen on Windows

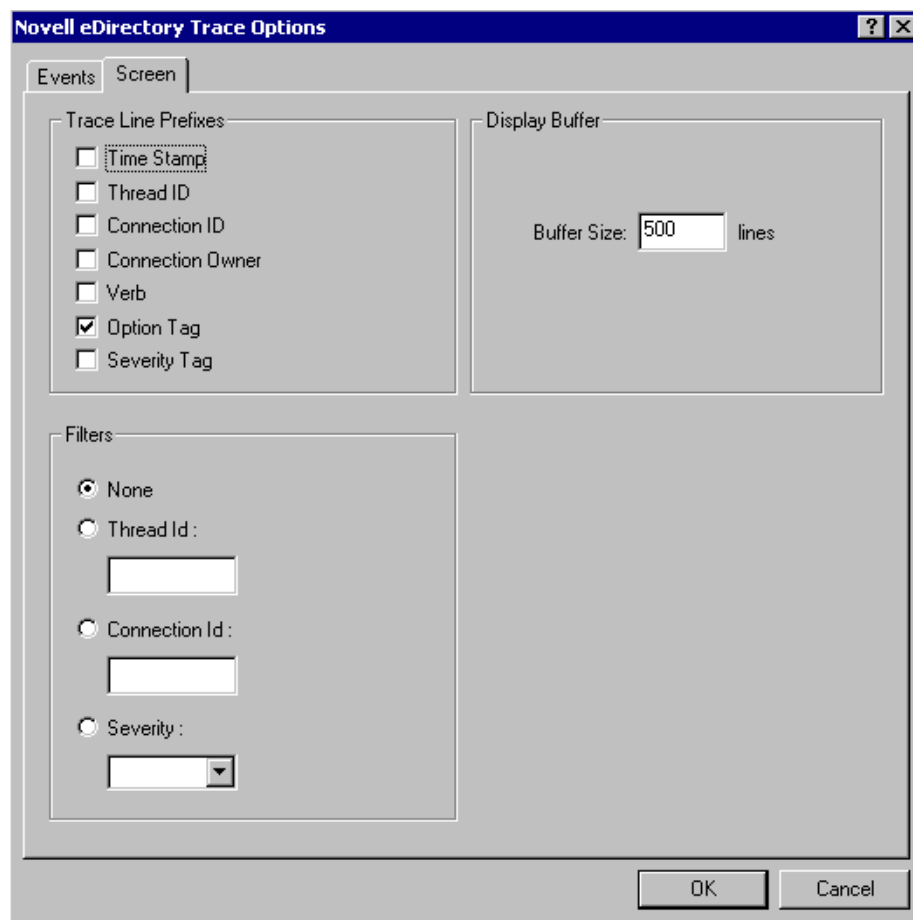

- 4 Click on the *Screen* tab.
- 5 Select the filter option from the *Filters* group and enter the filter value.

You can filter the messages based on:

- ◆ Thread ID
- ◆ Connection ID
- ◆ Severity

Before selecting any of the filters, ensure that it is enabled under *Trace Line Prefixes*.

You can also disable the filtering by selecting *None* or unselecting the filter option.

NOTE: If you've selected *Thread ID* or *Connection ID* as your filter option and enter a value that does not exist, then the messages won't be displayed on the screen. However, all the other messages will still get logged to the `ndstrace.log` file.

11.4 iMonitor Message Filtering

You can filter the iMonitor trace messages based on the connection ID, thread ID, or error number.

To filter based on the connection ID and thread ID, ensure that you have enabled them in the Trace Configuration tab.

For more information, refer to the iMonitor online help.

11.5 SAL Message Filtering

SAL has been enhanced to log extensive information on errors on demand. Function calls can be traced with arguments in the debug builds.

11.5.1 Configuring the Severity Levels

You can use the SAL_LogLevels parameter to configure the severity levels for the SAL messages. SAL_LogLevels is a comma separated list of desired log levels.

The log levels are explained in the table below:

Table 11-2 SAL Message Filtering Parameters

Parameter Name	Description
LogCrit	Critical Messages. This level is enabled by default. After a critical error is logged, the system shuts down.
LogErr	All Error messages. The system continues to function, but the results are unpredictable.
LogWarn	Warning messages. This is just a warning given so that you are aware of some impending error.
LogInfo	Informational messages.
LogDbg	Debug messages used for debugging at the time of development. These messages are compiled out from a release build to reduce the binary size.
LogCall	Traces the function calls. These are subset of Debug messages.
LogAll	Enables all the messages except LogCall.

A '-' at the beginning of a specific log level disables that level.

Examples

To filter based on all the log levels, except LogInfo and LogDbg, complete the following steps:

Linux and UNIX

- 1 Stop ndsd.
- 2 Type the following command:

```
export SAL_LogLevels=LogAll,-LogInfo,-LogDbg
```

- 3 Start ndsd.

NetWare

1 Unload `ds.nlm`.

2 Type the following command:

```
env SAL_LogLevels=LogAll,-LogInfo,-LogDbg=true
```

3 Load `ds.nlm`.

Windows

1 Shutdown the `DHost`.

2 Type the following command at command prompt:

```
set SAL_LogLevels=LogAll,-LogInfo,-LogDbg
```

```
c:\novell\nds>dhost.exe /datadir=c:\novell\nds\DIBFiles\
```

3 Restart `DHost`.

11.5.2 Setting the Log File Path

You can use the `SAL_LogFile` environment variable to specify the log file location. This can be a valid file name with a valid path, or one of the following.

- ♦ **Console:** All messages will be logged to the console
- ♦ **Syslog:** In Linux and UNIX, the messages will go to the syslog. On NetWare and Windows, messages are logged into a file with the name `syslog`. This is the default behavior for logging. All critical errors are always logged to syslog unless it is disabled specifically.

Offline Bulkload Utility: Idif2dib

12

ldif2dib is a new utility introduced with Novell eDirectory 8.8 for bulkloading data from LDIF files to the eDirectory database. This is an offline utility and achieves faster bulkloads compared to the other online tools.

The following table lists the platforms for which ldif2dib is supported.

Feature	Solaris	Linux	AIX	Windows
ldif2dib	✓	✓	✓	✓

12.1 Need for ldif2dib

ldif2dib utility is needed when a large user database needs to be populated with entries from an LDIF file. Online tools such as ice, ldapmodify are slower than ldif2dib in this respect, due to overheads associated with online bulk load such as schema checking, protocol translation and access control checks. ldif2dib allows for fast up time when a large user database needs to be populated and when initial down time is not an issue.

12.2 For More Information

For more information on this utility, refer to “Offline Bulkload Utility” of eDirectory 8.8 Administration Guide.

eDirectory Backup with SMS

13

Novell Storage Management Services (SMS) is an API framework consumed by backup applications to provide a complete backup solution. The SMS framework is implemented by two main components:

- ◆ Storage Management Data Requester (SMDR)
- ◆ Target Service Agent (TSA)

The TSA for the eDirectory (tsands) services eDirectory targets and provides an implementation of the Novell Storage Management Services API for the directory trees. Applications can be written on top of SMS API to provide a complete backup solution.

The TSA for NDS was already available on Netware, now this support has been extended for Linux.

Auditing is one of the primary functionalities that an administrator will be interested in, while evaluating a directory. eDirectory event mechanism facilitates eDirectory auditing. Because the applications are largely adopting the LDAP protocol for accessing directories, the requirement of auditing LDAP operations is becoming prevalent.

14.1 Need for LDAP Auditing

This event mechanism was noticeably absent in the existing eDirectory LDAP server that could not provide sufficient LDAP information. Though NDS event system produced events for all eDirectory operations, most of this information was insufficient or irrelevant for an application to audit the LDAP server. Information that covers protocol and bind details, network address, authentication methods, authentication types, LDAP search and transaction details, and so on, that is vital for auditing an LDAP server, was not available with the NDS events. Applications developers found it difficult to write to LDAP audit applications based on these events

Because LDAP is an important interface of eDirectory, to provide a mechanism for applications to audit eDirectory LDAP server, a new LDAP event subsystem is introduced in Novell® eDirectory 8.8™ SP3 version. This subsystem generates LDAP specific events with all the relevant information for an application to audit an LDAP server. This is known as LDAP Auditing.

14.2 Using LDAP Auditing

LDAP Auditing enables the applications to monitor/audit LDAP operations such as Add, Modify, Search, and so on, and fetches useful information from the LDAP server such as the connection information, the client IP to which the server was connected at the time of LDAP operation, the message ID, the result code of the operation, and so on.

LDAP Auditing can be exercised through the SDK "LDAP Libraries for C", that provides the client side interface for this feature through new LDAP structures and events. (will give the link to SDK doc here...not available right now).

14.3 For More Information

Refer to the following for more information on LDAP Auditing Events:

- [Configuring LDAP Services for Novell eDirectory \(http://www.novell.com/documentation/edir88/edir88/index.html?page=/documentation/edir88/edir88/data/ahlmb7h.html\)](http://www.novell.com/documentation/edir88/edir88/index.html?page=/documentation/edir88/edir88/data/ahlmb7h.html) in the *Novell eDirectory 8.8 Administration Guide*.
- [NDK: LDAP Tools \(http://developer.novell.com/documentation/cldap/ltoolenu/data/hevgtl7k.html\)](http://developer.novell.com/documentation/cldap/ltoolenu/data/hevgtl7k.html) in the *LDAP Tools Guide*.

For information on LDAP tools, see [LDAP Tools \(http://developer.novell.com/ndk/doc/cldap/index.html?ldaplibc/data/a6cup29.html\)](http://developer.novell.com/ndk/doc/cldap/index.html?ldaplibc/data/a6cup29.html).

This chapter covers miscellaneous new features with Novell® eDirectory™ 8.8.

- ◆ [Section 15.1, “Security Object Caching,” on page 81](#)
- ◆ [Section 15.2, “Subtree Search Performance Improvement,” on page 81](#)
- ◆ [Section 15.3, “Localhost Changes,” on page 82](#)
- ◆ [Section 15.4, “256 File Handler on Solaris,” on page 82](#)
- ◆ [Section 15.5, “Memory Manager on Solaris,” on page 82](#)
- ◆ [Section 15.6, “Nested Groups,” on page 82](#)

15.1 Security Object Caching

The security container is created off the root partition when the first server is installed in the tree and holds information such as global data, security policies, and keys.

After universal password was introduced, whenever a user logged into eDirectory through NMAS®, NMAS accessed the information in the security container to authenticate the login. When the partition having the security container was not present locally, NMAS accessed the server, which had this partition. This had an adverse impact on the performance of NMAS authentication. The situation was worse in the scenarios where the server containing the partition having the security container had to be accessed over WAN links.

To resolve this, with eDirectory 8.8, the security container data is cached onto the local server. Therefore, NMAS does not need to access the security container located on a different machine whenever a user logs in, it can easily access it locally. This increases the performance. Adding the partition having security container to local server improves the performance, but it might not be feasible in scenarios where there are too many servers.

If the actual data in the security container changes on the server containing the security container partition, the local cache is refreshed by a background process called backlinker. By default, backlinker runs every thirteen hours and it pulls the modified data from remote server. In case, the data needs to be synchronized immediately, you can schedule backlinker on the local server either through iMonitor, ndstrace (Linux and UNIX), dstrace (Netware®), or ndscons (Windows). For more information, refer to the iMonitor online help or the ndstrace manpage.

The security object caching feature is enabled by default. If you do not want backlinker to cache any data, remove CachedAttrsOnExtRef from the NCP server object.

15.2 Subtree Search Performance Improvement

The eDirectory subtree search performance for a large tree with a significantly nested structure remains flat irrespective of the base DN of the search. This has been resolved by using an AncestorID attribute. The AncestorID attribute is a list of entryIDs of all ancestors, associated with each entry. This AncestorID is used internally during the subtree search and therefore restricts the scope of the search.

This attribute gets populated while adding an entry and after upgrade for all the entries in the DIB and is repopulated for all the entries in the subtree after a subtree is moved. However, the subtree search will not use the AncestorID attribute while populating the attribute after upgrade and subtree move. Therefore, the subtree performance remains similar to pre-eDirectory 8.8 subtree search performance.

To verify if AncestorIDs are updated after upgrade:

Once the AncestorIDs are populated, the NDS Object Upgrade version changes to 6 or more. You can view this using iMonitor in the *DIB History* section of Agent Information.

To verify if AncestorIDs are updated after the subtree move operation:

While the AncestorIDs are being populated, the attribute UpdateInProgress in the Pseudo Server object has the list of entry IDs of the partition Root of the subtree. Once the AncestorIDs are populated, the attribute will not be present in the Pseudo Server.

ndsrepair updates the AncestorID attribute if it is invalid.

15.3 Localhost Changes

eDirectory 8.8 servers do not listen on loopback address. Utilities using localhost need to be changed to hostname resolve or IP address.

If any third party tool or utility resolves through localhost then that needs to be changed to resolve through hostname or IP address and not through the localhost address.

15.4 256 File Handler on Solaris

Earlier, Solaris 2.x stdio streams implementation could use only a maximum of 256 file descriptors. This was insufficient for eDirectory to function correctly. eDirectory 8.8 provides a stub library to overcome this limit.

15.5 Memory Manager on Solaris

The earlier releases of eDirectory on Solaris used Geodesic*, a third-party product as the memory manager. With this release, eDirectory 8.8 does not include any third-party memory allocators, but makes use of the native memory manager.

This has no impact on the performance of eDirectory. In most cases, the performance either has improved or remained the same as third-party allocators.

15.6 Nested Groups

eDirectory 8.8 SP2 supports grouping of groups; therefore, provides a more structured form of grouping. This feature is called Nested Groups. Currently, nesting is allowed for static groups.

Nesting can have multiple levels upto 200.

For more information on Nested Groups, refer to the *Novell eDirectory 8.8 Administration Guide* (<http://www.novell.com/documentation/edir88/index.html>)