

Getting Started with OES 2 and Virtualized NetWare®

Open Enterprise Server 2 SP3

April 17, 2012

Novell.

Legal Notices

Novell, Inc., makes no representations or warranties with respect to the contents or use of this documentation, and specifically disclaims any express or implied warranties of merchantability or fitness for any particular purpose. Further, Novell, Inc., reserves the right to revise this publication and to make changes to its content, at any time, without obligation to notify any person or entity of such revisions or changes.

Further, Novell, Inc., makes no representations or warranties with respect to any software, and specifically disclaims any express or implied warranties of merchantability or fitness for any particular purpose. Further, Novell, Inc., reserves the right to make changes to any and all parts of Novell software, at any time, without any obligation to notify any person or entity of such changes.

Any products or technical information provided under this Agreement may be subject to U.S. export controls and the trade laws of other countries. You agree to comply with all export control regulations and to obtain any required licenses or classification to export, re-export or import deliverables. You agree not to export or re-export to entities on the current U.S. export exclusion lists or to any embargoed or terrorist countries as specified in the U.S. export laws. You agree to not use deliverables for prohibited nuclear, missile, or chemical biological weaponry end uses. See the [Novell International Trade Services Web page \(http://www.novell.com/info/exports/\)](http://www.novell.com/info/exports/) for more information on exporting Novell software. Novell assumes no responsibility for your failure to obtain any necessary export approvals.

Copyright © 2010 Novell, Inc. All rights reserved. No part of this publication may be reproduced, photocopied, stored on a retrieval system, or transmitted without the express written consent of the publisher.

Novell, Inc.
1800 South Novell Place
Provo, UT 84606
U.S.A.
www.novell.com

Online Documentation: To access the latest online documentation for this and other Novell products, see the [Novell Documentation Web page \(http://www.novell.com/documentation\)](http://www.novell.com/documentation/).

Novell Trademarks

For Novell trademarks, see [the Novell Trademark and Service Mark list \(http://www.novell.com/company/legal/trademarks/tmlist.html\)](http://www.novell.com/company/legal/trademarks/tmlist.html).

Third-Party Materials

All third-party trademarks are the property of their respective owners.

Contents

About This Guide	7
1 Installing the OES 2 SP3 Server in Your Getting-started Lab	9
1.1 Getting-started Lab Setup Requirements	9
1.2 Obtaining Installation Media	10
1.2.1 Identifying the Files to Download	11
1.2.2 Downloading the Files	11
1.2.3 Creating the Installation Media	11
1.3 Installing the Server Software	11
1.3.1 Prerequisites	12
1.3.2 Procedure	12
1.4 Setting the Root Password, Configuring the Network, and Updating the Server	14
1.5 Configuring eDirectory and OES Services	17
1.6 Setting Up the Graphical User Interface	19
1.7 Completing the Update Process	20
1.8 Setting Up the Server as an SLP Directory Agent	20
1.9 Accessing iManager	21
1.10 Configuring the Browser for the eDirectory CA	22
1.10.1 Exporting the CA's Self-Signed Certificate	22
1.10.2 Importing the CA Certificate into Mozilla Firefox 3.6 on Windows	23
1.10.3 Importing the CA Certificate into Windows Explorer 8 on Windows	23
1.11 Enabling Pop-Ups for iManager	23
1.11.1 Firefox 3.6.x	23
1.11.2 Internet Explorer 8	24
2 Installing a NetWare Virtual Machine	25
2.1 Virtualization Host Server Requirements	25
2.2 Installing the Virtualization Host Server	26
2.2.1 Prerequisites	27
2.2.2 Starting the Installation	27
2.2.3 Setting the Root Password, Configuring the Network, and Updating the Server	29
2.2.4 Configuring LDAP and OES Services	32
2.2.5 Setting Up the Graphical User Interface	33
2.2.6 Booting with the Xen Kernel	34
2.3 Installing the NetWare 6.5 SP8 Virtual Machine	34
2.3.1 Disabling the Alt+Esc Shortcut on the VM Host Server	34
2.3.2 Downloading the NetWare ISO File	35
2.3.3 Creating a Virtual Machine and Installing NetWare	35
3 eDirectory, Users and Groups, and Identity Services	41
3.1 Using the eDirectory Information in This Guide	41
3.2 An Introduction to eDirectory Planning	42
3.2.1 Your Getting-started Lab's eDirectory Tree	42
3.2.2 Your Current Getting-started Lab Tree	43
3.2.3 Expanding Your Getting-started Lab Tree	44
3.3 Setting Up Role-Based Services	45
3.4 Updating the iManager Plug-in Modules	46

3.5	Creating a Context for Your Users and Groups	46
3.6	Assigning a Password Policy to Your Users	47
3.7	Creating NCP and NSS Volumes for Home Directories	48
3.7.1	Home Directories on OES 2	48
3.7.2	Home Directories on NetWare 6.5	50
3.7.3	Summary of Getting-started Lab Home Directories and Purposes	51
3.8	Creating Users	51
3.9	A Note about Identity Manager 3.6 Bundle Edition	54
4	eDirectory Linux Access (LUM)	55
4.1	Overview of Linux User Management	55
4.2	Creating Group Objects	56
4.3	Enabling the LUMUsers Group for Linux User Management (LUM)	57
4.4	Allowing SSH Access	58
4.4.1	Allowing SSH Access Through the Firewall	58
4.4.2	Adding SSH as an Allowed Service in LUM	58
4.4.3	Verifying SSH Access	58
4.5	Creating a Home Directory for the linux* Users	59
4.5.1	Using the File Browser	59
4.5.2	Using Terminal Commands	60
5	Novell CIFS on OES 2	63
5.1	Overview of Novell CIFS	63
5.2	Setting the Search Context	64
5.3	Making Novell CIFS Shares Available to CIFS Users	65
5.4	Novell CIFS Users Access Rights	65
6	Novell AFP	67
6.1	Overview	67
6.2	Setting the Search Context	68
6.3	Making NSS Volumes Available to AFP Users	68
6.4	Novell AFP Users Access Rights	68
7	NetWare CIFS and AFP on OES 2	69
7.1	Overview	69
7.2	Enabling NFAP Services on the LAB_NW Server	70
7.2.1	Creating a Share for the HOME_NW Volume	70
7.2.2	Specifying a Search Context	70
8	iFolder 3.8	73
8.1	Overview of iFolder	73
8.2	Installing the iFolder Client	74
8.3	Creating Corresponding Windows Users	75
8.4	Refreshing the List of iFolder Users	75
8.5	Configuring iFolder Accounts and Creating iFolders	76
9	iPrint	79
9.1	Overview of iPrint	79
9.2	Creating an eDirectory Context for Printers	80

9.3	Creating a Print Driver Store	81
9.4	Creating a Print Manager Object	81
9.5	Adding Printer Drivers to the Driver Store from the Windows Platforms	82
9.6	Creating iPrint Printer Objects	83
10 NetStorage		85
10.1	Overview of NetStorage	85
10.2	Making Directories Accessible Through NetStorage	86
10.2.1	NCP Users Have Automatic Access to Their Home Directories	86
10.2.2	Creating a Storage Location Object in iManager	87
10.2.3	Adding the Object to a Storage Location List	88
10.2.4	SSH and NetStorage Administration	88
11 Getting Acquainted with OES		91
11.1	Preparing Files for the Getting-started Lab Exercises	91
11.2	Exercises for linux1_lum-edir	92
11.2.1	What linux1_lum-edir Can Do	92
11.2.2	Using NetStorage	93
11.3	Exercises for linux2_lum-edir	94
11.3.1	What linux2_lum-edir Can Do	94
11.3.2	Using NetStorage	95
11.3.3	Using iPrint	96
11.4	Exercises for ncp_lum-edir	96
11.4.1	What ncp_lum-edir Can Do	97
11.4.2	Using NetStorage	97
11.5	Exercises for ncp_edir	98
11.5.1	What ncp_edir Can Do	98
11.5.2	Using iFolder	99
11.5.3	Using NetStorage	100
11.6	Exercises for nss_edir	101
11.6.1	What nss_edir Can Do	101
11.6.2	Using NetStorage	102
11.7	Administrative Tasks Available in NetStorage	103
11.7.1	Recovering the junk.txt File	103
11.7.2	Setting Rights to TeamProjectReadOnly.txt	103
11.7.3	Setting Rights to TeamProjectWrite.txt	104
11.8	Exercises for nss_lum-edir	104
11.8.1	What nss_lum-edir Can Do	104
11.8.2	Using Novell CIFS File Services	105
11.9	Exercises for nw_edir	106
11.9.1	What nw_edir Can Do	106
11.9.2	Using NetWare CIFS File Services	107
11.10	Macintosh Exercises and Novell AFP	107
11.11	What's Next	107
A Supplementary Information		109
A.1	NSS Partitions, Pools, and Volumes	109
A.2	iManager Tomcat Error	111
B Documentation Updates		113

About This Guide

In Novell® Open Enterprise Server (OES) 2 SP2 and earlier, this guide was entitled the *OES Lab Guide*.

Starting with OES 2 SP3, the title has changed to better reflect the purposes explained below and documented in the following sections:

- ♦ [Chapter 1, “Installing the OES 2 SP3 Server in Your Getting-started Lab,” on page 9](#)
- ♦ [Chapter 2, “Installing a NetWare Virtual Machine,” on page 25](#)
- ♦ [Chapter 3, “eDirectory, Users and Groups, and Identity Services,” on page 41](#)
- ♦ [Chapter 4, “eDirectory Linux Access \(LUM\),” on page 55](#)
- ♦ [Chapter 5, “Novell CIFS on OES 2,” on page 63](#)
- ♦ [Chapter 6, “Novell AFP,” on page 67](#)
- ♦ [Chapter 7, “NetWare CIFS and AFP on OES 2,” on page 69](#)
- ♦ [Chapter 8, “iFolder 3.8,” on page 73](#)
- ♦ [Chapter 9, “iPrint,” on page 79](#)
- ♦ [Chapter 10, “NetStorage,” on page 85](#)
- ♦ [Chapter 11, “Getting Acquainted with OES,” on page 91](#)
- ♦ [Appendix A, “Supplementary Information,” on page 109](#)

To install OES 2 SP3 in a getting-started lab prior to installing it in a production environment, we recommend using the following documentation.

- ♦ [OES 2 SP3 Readme](#)
- ♦ [OES 2 SP3: Planning and Implementation Guide](#)
- ♦ [OES 2 SP3: Installation Guide](#)

Guide Purposes

This guide is designed to help you with your transition from NetWare® to OES 2 by helping you to get acquainted with basic OES services.

The information and instructions it contains help you to do the following:

- ♦ Install an OES 2 SP3 server into a new eDirectory™ tree named EXAMPLE_TREE
- ♦ Install selected OES 2 components on the server
- ♦ Install an OES 2 SP3 virtual machine host server, create a virtual machine (VM) on the server, and install NetWare 6.5 SP8 on the VM
- ♦ Create seven different user types, at least one of which should closely align with the users on your network
- ♦ Perform simple tasks to get acquainted with basic OES 2 services on a Windows XP or Windows 7 workstation.

Work through the Guide Sequentially

The sections in this guide are designed to be accessed sequentially, thus guiding you through the main tasks of setting up an OES 2 environment that you can then explore further as desired.

If You Want to Use This Guide as a Reference

If you want to install additional OES 2 servers, create a different tree structure than the one specified in this guide, or diverge from the instructions presented, you can still use these instructions as a basic outline for setting up OES 2 services in a getting-started lab environment. However, be aware that any divergence from the instructions presented or the order they are presented in, can cause ripple effects through the rest of the guide. If you need to diverge, refer to the information found in the following guides for assistance:

- ♦ *[OES 2 SP3: Planning and Implementation Guide](#)*
- ♦ *[OES 2 SP3: Installation Guide](#)*
- ♦ *[OES2 SP3: Linux Tips for NetWare Administrators](#)*
- ♦ *[NW65 SP8: Installation Guide](#)*

Feedback

We want to hear your comments and suggestions about this manual and the other documentation included with this product. Please use the User Comments feature at the bottom of each page of the online documentation, or go to www.novell.com/documentation/feedback.html and enter your comments there.

Documentation Conventions

In this documentation, a greater-than symbol (>) is used to separate actions within a step and items within a cross-reference path.

1 Installing the OES 2 SP3 Server in Your Getting-started Lab

Use the instructions in this section to install Novell® Open Enterprise Server 2 SP3 (OES 2 SP3) in your getting-started lab.

- ♦ [Section 1.1, “Getting-started Lab Setup Requirements,” on page 9](#)
- ♦ [Section 1.2, “Obtaining Installation Media,” on page 10](#)
- ♦ [Section 1.3, “Installing the Server Software,” on page 11](#)
- ♦ [Section 1.4, “Setting the Root Password, Configuring the Network, and Updating the Server,” on page 14](#)
- ♦ [Section 1.5, “Configuring eDirectory and OES Services,” on page 17](#)
- ♦ [Section 1.6, “Setting Up the Graphical User Interface,” on page 19](#)
- ♦ [Section 1.7, “Completing the Update Process,” on page 20](#)
- ♦ [Section 1.8, “Setting Up the Server as an SLP Directory Agent,” on page 20](#)
- ♦ [Section 1.9, “Accessing iManager,” on page 21](#)
- ♦ [Section 1.10, “Configuring the Browser for the eDirectory CA,” on page 22](#)
- ♦ [Section 1.11, “Enabling Pop-Ups for iManager,” on page 23](#)

1.1 Getting-started Lab Setup Requirements

For the tasks and exercises described in this guide, you need the following:

- ❑ A server-class computer with the following:

Component	Minimum	Recommended
Processor	Pentium* II or AMD* K7 450 MHz	Pentium III, Pentium III Xeon*, Pentium 4, Intel* Xeon 700 MHz, AMD K8 CPUs (Athlon64 and Opteron*), Intel EM64T or higher processor
RAM	1 GB	2 GB
Display adapter	Super VGA	VESA 1.2-compliant, high resolution
Display monitor	Compatible with adapter	
CD/DVD drive	Support for the EITorito specification	

Component	Minimum	Recommended
Hard drive	40 GB	
(All data will be erased)		
Network card	Ethernet 100 Mbps	
IP address	<ul style="list-style-type: none"> ◆ IP address on the getting-started lab subnet. For example, 192.168.1.100. ◆ Subnet mask. For example, 255.255.255.0. ◆ Default gateway. For example, 192.168.1.1. 	
Mouse	Not required	USB or PS/2*

- A network printer with an assigned static IP address and a connection to your getting-started lab network.
- A Windows workstation with
 - ◆ One of the following platforms installed:
 - ◆ Windows XP
 - ◆ Windows 7
 - ◆ An Ethernet 100 Mbps adapter
 - ◆ An IP address on the same subnet as the server
 - ◆ Mozilla* Firefox* browser installed. (This is optional, but Firefox is the assumed browser for most of the instructions in this guide)
 - ◆ A print driver installed on the workstation for the network printer listed above.
- (Optional for exploring Novell AFP and iPrint) An Apple* Macintosh* workstation with
 - ◆ Mac OS* 10.4 or later installed
Novell AFP supports earlier versions of Mac OS, but iPrint doesn't.
 - ◆ An Ethernet adapter
 - ◆ An IP address on the same subnet as the server
 - ◆ A print driver installed on the workstation for the network printer listed above.

1.2 Obtaining Installation Media

To complete the instructions in this guide, you need to download various ISO files, depending on your hardware.

- ◆ [Section 1.2.1, "Identifying the Files to Download," on page 11](#)
- ◆ [Section 1.2.2, "Downloading the Files," on page 11](#)
- ◆ [Section 1.2.3, "Creating the Installation Media," on page 11](#)

1.2.1 Identifying the Files to Download

You need to download the set of files in [Table 1-1](#) that matches the architecture (32-bit or 64-bit) of your server computers:

Table 1-1 Files to Download

Platform	Files needed
32-bit server with CD/DVD drive	<ul style="list-style-type: none">◆ SLES-10-SP3-DVD-i386-GM-DVD1.iso◆ OES2-SP3-i386-CD1.iso
64-bit server with CD/DVD drive	<ul style="list-style-type: none">◆ SLES-10-SP3-DVD-x86_64-GM-DVD1.iso◆ OES2-SP3-x86_64-CD1.iso

1.2.2 Downloading the Files

After identifying which files you need to download:

- 1 Go to [“Downloading OES 2 SP3 Software from the Novell Web Site”](#) in the *OES 2 SP3: Planning and Implementation Guide*.
- 2 Complete all the steps in the section, except the instructions on deciding which files to download. You should have already identified the files you need, using the list in [Section 1.2.1, “Identifying the Files to Download,”](#) on page 11.
- 3 Be sure to print the pages as instructed, record the two activation codes, print and check the MD5 verification checksums, and so on.
- 4 After you have downloaded all of the files you need, continue with [Creating the Installation Media](#).

1.2.3 Creating the Installation Media

To prepare physical installation media:

- 1 Go to [“Preparing Physical Media for a New Server Installation or an Upgrade”](#) in the *OES 2 SP3: Installation Guide* and use the instructions there to create media for installing your OES 2 server.

Continue with [Installing the Server Software](#).

1.3 Installing the Server Software

Complete the instructions in the following sections.

- ◆ [Section 1.3.1, “Prerequisites,”](#) on page 12
- ◆ [Section 1.3.2, “Procedure,”](#) on page 12

1.3.1 Prerequisites

Before installing OES 2 on your server, you must complete the following tasks:

- Ensure that the server computer meets the requirements outlined in [Section 1.1, “Getting-started Lab Setup Requirements,”](#) on page 9.
- Prepare the software for installation as explained in [Section 1.2, “Obtaining Installation Media,”](#) on page 10.

1.3.2 Procedure

WARNING: This procedure permanently erases any data currently on your server’s hard drive.

- 1 Prepare the BIOS on your server machine so that it will boot from the DVD drive first.
- 2 Insert the SLES 10 SP4 DVD1 into your server and reboot the machine.
- 3 When the boot selection page appears, immediately press the Down-arrow key to select the *Installation* option, then press Enter.
If you don’t respond before the machine starts booting from the hard disk, reboot the server and repeat this step.
- 4 After the boot process finishes, select an installation language, then click *Next*.
- 5 Read and agree to the software license agreement, then click *Next*.
- 6 Select *New Installation*, select the *Include Add-On Products from Separate Menu* option, then click *Next*.
- 7 On the Add-on Product Installation page, click *Add*.
- 8 Select *CD*, then click *Next*.
- 9 Insert the OES 2 SP3 CD as prompted, then click *Continue*.
- 10 After the catalog is added, read and agree to the OES 2 license agreement, then click *Next > Next*.
- 11 Select the time zone for the server, then click *Next*.
- 12 On the Installation Settings page, click *Partitioning*.
If your server has existing partitions, the OES install tries to add new SLES partitions to them.
- 13 To ensure a clean install, use the following table to navigate the partitioning pages and prepare your system disk.

IMPORTANT: The steps in the following table prepare the system disk for management by the EVMS volume manager. This is only required if you want to have NSS volumes on the system disk, and is not the default use case. We have included the process in this guide to provide exposure to installing NSS volumes on a single-drive server.

The steps also assume that you are installing on a machine that was previously used, and that you want to remove all of the existing data. If that is not the case, see [“Installing with EVMS as the Volume Manager of the System Device”](#) in the *OES 2 SP3: Installation Guide* for other installation options.

Keep in mind that the guide assume that you can use 40GB of the hard drive space on the machine that you are installing OES 2 on.

Page Name	Action
Suggested Partitioning	<ol style="list-style-type: none"> 1. Select <i>Create Customer Partition Setup</i>. 2. Click <i>Next</i>.
Preparing Hard Disk—Step 1	<ol style="list-style-type: none"> 1. Select the hard disk you are installing on. 2. Click <i>Next</i>.
Preparing Hard Disk—Step 2	<ol style="list-style-type: none"> 1. Click <i>Use Entire Hard Disk</i>. This only appears when the disk contains existing partitions. WARNING: This erases all data from the disk you are installing to. 2. Click <i>Create EVMS Based Proposal > Next</i>.

14 On the Installation Settings page, click *Software*.

Use the following table to navigate and configure the software pages:

Page Name	Action
Software Selection and System Tasks	<ol style="list-style-type: none"> 1. Under <i>OES Services</i>, select (or confirm the selection of) the following: <ul style="list-style-type: none"> ♦ <i>Novell AFP</i> ♦ <i>Novell CIFS</i> ♦ <i>Novell eDirectory*</i> ♦ <i>Novell iFolder</i> ♦ <i>Novell iManager</i> ♦ <i>Novell iPrint</i> ♦ <i>Novell NCP Server/Dynamic Storage Technology*</i> ♦ <i>Novell NetStorage</i> ♦ <i>Novell Storage Services*</i> <p>Services marked with an asterisk (*) are selected with AFP and CIFS.</p> <p><i>Novell Backup/Storage Management Services (SMS)</i>, <i>Novell Linux User Management</i>, and <i>Novell Remote Manager</i> are all selected by default when any OES selections are made, and they are installed on every OES 2 server.</p> 2. Click <i>Accept</i>.
agfa fonts	<ol style="list-style-type: none"> 1. Click <i>Accept</i>.
Installation Settings	<ol style="list-style-type: none"> 1. Click <i>Accept</i>.
Confirm Installation	<ol style="list-style-type: none"> 1. Click <i>Install</i>.

15 When prompted, insert the SLES 10 media and click *Retry*.

Insert DVD 1 when you are prompted for any SLES 10 media.

After the files are copied, the system configuration takes a few minutes to complete.

16 Continue with [Setting the Root Password, Configuring the Network, and Updating the Server](#).

1.4 Setting the Root Password, Configuring the Network, and Updating the Server

After the initial system configuration and system reboot, the installation needs information about the root user and the network.

1 Use the following table to navigate and complete the various configuration pages.

Page Name	Action
Password for the System Administrator "root"	<ol style="list-style-type: none"> 1. Enter and confirm the <code>root</code> user password, then click <i>Next</i>.
Hostname and Domain Name	<ol style="list-style-type: none"> 1. In the <i>Host Name</i> field, type the DNS hostname for the IP address you are assigning to the server. For example, <code>myserver</code>. 2. In the <i>Domain Name</i> field, type the <i>DNS Domain Name</i> for your network. For example, <code>mysite.company.example.com</code>. 3. Deselect <i>Change Hostname via DHCP</i>. 4. Click <i>Next</i>.
Network Configuration	<ol style="list-style-type: none"> 1. Click <i>Network Interfaces</i>.
Network Card Configuration Overview	<ol style="list-style-type: none"> 1. If your server has multiple network cards, select the card the server will use. 2. Click <i>Edit</i>. 3. Select <i>Static Address Setup</i>. 4. In the <i>IP Address</i> field, type the IP address for the server. For example, <code>192.168.1.100</code> 5. Change the <i>Subnet Mask</i> if needed. For example, <code>255.255.255.0</code>. 6. Click <i>Host Name and Name Server</i>.
Host Name and Name Server Configuration	<ol style="list-style-type: none"> 1. Type the IP address of at least one name server and type your DNS domain name in the <i>Domain Search</i> field. For example, <code>company.example.com</code>. 2. Click <i>OK</i>.
Network Address Setup	<ol style="list-style-type: none"> 1. Click <i>Routing</i>.
Routing Configuration	<ol style="list-style-type: none"> 1. Type the IP address of the default gateway for your getting-started lab subnet. For example, <code>192.168.1.1</code>. 2. Click <i>OK</i>.
Network Address Setup	<ol style="list-style-type: none"> 1. Click <i>Next</i>.
Network Card Configuration Overview	<ol style="list-style-type: none"> 1. Click <i>Next</i>.
Network Configuration	<ol style="list-style-type: none"> 1. Click <i>Next</i>.
Test Internet Connection	<p>You will need to register your server on the Internet to download the latest patches, so you should test the Internet connection at this point to make sure everything is configured correctly.</p> <ol style="list-style-type: none"> 1. Select <i>Yes, Test Connection to the Internet</i>. 2. Click <i>Next</i>.
Running Internet Connection Test	<p>After a few moments, the <i>Test Status</i> should indicate <i>Success</i>.</p> <p>If it does not, you need to click <i>Back</i> and fix your network configuration and the connection to the Internet. It is essential that OES 2 servers always have the latest security and other critical patches downloaded and installed.</p> <ol style="list-style-type: none"> 1. Click <i>Next</i>.

Page Name	Action
Novell Customer Center Configuration	1. Click <i>Next</i> . The server establishes a connection with the Novell Customer Center.
Manual Interaction Required	1. Click <i>Continue</i> .
Novell Customer Center System Registration	1. In the fields indicated, type and confirm the e-mail address to which you want administrative notifications sent. 2. In the <i>Activation code for SLES components</i> field, type the SLES activation code you noted or printed while downloading the image files. If this code is not entered, the server can't download updates and patches through the Novell patch channels. For the OES 2 SP3 release, downloading the SLES patches is critical for service configuration success. 3. In the <i>Activation code for OES components</i> field, type the OES 2 activation code you noted or printed while downloading the image files. If this code is not entered, the same patch channel restriction applies as for SLES. 4. Click <i>Submit</i> . Your registration information is sent to the Customer Center. This might take a couple of minutes to complete. 5. Click <i>Continue</i> . The update server is added to your system configuration. Again, this might take a few minutes.
Novell Customer Center Configuration pop-up	1. Click <i>OK</i> .

Page Name	Action
Online Update	<p>Depending on the patches that are in the Update channels, you might need to run the update process more than once.</p> <ol style="list-style-type: none"> 1. Select <i>Run Update</i>, then click <i>Next</i>. 2. WARNING: At this point it is critical that you deselect any patches that will cause the server to reboot before the installation process completes. The <code>fstab</code> file is updated for compatibility with the EVMS volume manager at the end of the installation. If that doesn't happen before the server reboots, certain system resources, such as your network cards, won't be available on the system. <p>Deselect the <code>slesp3-kernel</code> Security update for the Linux kernel patch by clicking its checkbox twice.</p> 3. Click <i>Accept</i>. 4. If you see one or more YaST pop-ups indicating that a reboot is required, then you must click <i>Cancel</i> to deselect the patch or patches indicated. <p>The update patches are downloaded and installed.</p> 5. When both status bars indicate <i>100%</i>, click <i>Next</i>. <p>IMPORTANT: After the server installation completes and you log in as the root user, you will need to complete the update/patch process. Otherwise, your server resources won't be available the first time you reboot the server.</p>
Installation Settings	<ol style="list-style-type: none"> 1. Click <i>Next</i>.

- 2 Continue with [Configuring eDirectory and OES Services](#).

1.5 Configuring eDirectory and OES Services

For the exercises in this guide, you need specific eDirectory, NTP, and SLP configurations.

- 1 Use the following table to navigate and complete the eDirectory pages:

Page Name	Action
eDirectory Configuration - New or Existing Tree	<ol style="list-style-type: none"> In the <i>Tree Name</i> field, type <code>EXAMPLE_TREE</code>. Notice that the <i>Use eDirectory Certificates for HTTPS Services</i> option is selected. This option configures all of the HTTPS services (OES 2 and SLES 10) to use the new eDirectory tree's Organizational CA for certificate management and encryption of HTTPS communications. For more information on the value this adds to your network, see "Certificate Management" in the <i>OES 2 SP3: Planning and Implementation Guide</i>. Click <i>Next</i>.
eDirectory Configuration - New Tree Information	<ol style="list-style-type: none"> In the <i>FDN Admin Name with Context</i> field, type <code>CN=admin.O=COMPANY</code>. In this guide, the Admin User object is named <code>admin</code> (all lowercase) to differentiate the name from the object itself (Admin User), which is a standard eDirectory object and is always capitalized in the documentation by convention. The eDirectory Admin User object can have any name you choose, although most administrators use "admin." In this guide, all container objects, such as <code>COMPANY</code>, are created in uppercase so they are more easily distinguished in the illustrations and procedures. In the <i>Admin Password</i> and <i>Verify Admin Password</i> fields, specify the password for the eDirectory Admin User. Click <i>Next</i>.
eDirectory Configuration - Local Server Configuration	<ol style="list-style-type: none"> Change the server context to <code>OU=SERVERS.OU=LAB.O=COMPANY</code>. Click <i>Next</i>.
eDirectory Configuration - NTP and SLP	<p>Time synchronization is required for eDirectory.</p> <ol style="list-style-type: none"> Type the IP address or DNS name of the reliable, external Network Time Protocol (NTP) server you want the servers in your tree to use for time synchronization. Click <i>Next</i>.
SLP Configuration	<ol style="list-style-type: none"> Click <i>Yes</i> to confirm that SLP is not being configured at this time. Later in this guide you will configure this server as the SLP Directory Agent. For more information on SLP, see "SLP" in the <i>OES 2 SP3: Planning and Implementation Guide</i>.
Novell Modular Authentication Services	<ol style="list-style-type: none"> Click <i>Next</i>.
OES common proxy user Information	<ol style="list-style-type: none"> Click <i>Next</i>. This creates a common proxy user for some of the OES services you are installing. For more information, see "Common Proxy User - New in SP3" in the <i>OES 2 SP3: Planning and Implementation Guide</i>.

Page Name	Action
Novell Open Enterprise Server Configuration	<ol style="list-style-type: none"> 1. Click <i>NetStorage</i>. 2. Change the User Context to the following: OU=USERS . OU=LAB . O=COMPANY 3. Click <i>Next</i>. <p>The eDirectory and iManager configuration processes can take a few minutes or much longer depending on the server processor speed, etc. The other OES services should self-configure fairly quickly.</p>
User Authentication Method	<ol style="list-style-type: none"> 1. Click <i>Next</i>.
New Local User	<p>The local <code>root</code> user was created during the SLES install. On OES 2 servers, we recommend that all users except <code>root</code> be defined in eDirectory. Therefore, you don't create additional local users.</p> <ol style="list-style-type: none"> 1. Click <i>Next</i>.
Empty User Login	<ol style="list-style-type: none"> 1. Click <i>Yes</i>.
Release Notes	<ol style="list-style-type: none"> 1. Click <i>Next</i>. <p>The official OES 2 Release Notes (http://www.novell.com/documentation/oes2/oes_readme/data/readme.html) are published with the OES 2 Online Documentation (http://www.novell.com/documentation/oes2).</p>

2 Continue with [Setting Up the Graphical User Interface](#).

1.6 Setting Up the Graphical User Interface

Although most Linux servers don't have a graphical user interface loaded, the getting-started lab server you are installing runs the GNOME* interface by default.

When the Hardware Configuration page appears:

- 1 Review the Graphics Cards configuration to make sure your monitor was detected and that your color and resolution settings are the way you want them.
If the settings are correct, skip to [Step 3](#).
- 2 If the configuration is incomplete or wrong, click the blue links to configure your monitor, color, resolution, etc.
- 3 Click *Next*.
- 4 When the *Installation Completed* page appears, deselect *Clone This System for Autoyast*, then click *Finish*.
- 5 When the login splash page appears, continue with [Completing the Update Process](#).

1.7 Completing the Update Process

You must update the server at this point to avoid problems with system resources.

- 1 Log into the server as `root`.
- 2 Click the Software Updater icon .
- 3 In the Software Updater dialog, click *Update*.
- 4 In the Change Summary dialog, click *Apply*, then *Accept* the license agreement.
- 5 After the update is downloaded and installed, click *Close > Yes*.
- 6 After the system reboots, continue with [Section 1.8, “Setting Up the Server as an SLP Directory Agent,”](#) on page 20.

1.8 Setting Up the Server as an SLP Directory Agent

For OES 2 services to work, the OES 2 server must have one of the following:

- ♦ **An eDirectory replica installed on the server.** This is not automatic after the third server installed in a tree because it is not recommended to have more than three to five replicas in the tree.

This means that in a large network with many servers, most of the servers won't have replicas, which leaves only the OpenSLP option.

- ♦ **OpenSLP running on the server with eDirectory as a registered service.** This requires that you configure a network server (for example, the first server in the tree) as an SLP Directory Agent (DA), and then configure the other network servers that don't have an eDirectory replica to point to the DA server.

For the getting-started lab setup, you don't actually need SLP services set up because each of the two getting-started lab servers (this server and the NetWare VM) has an eDirectory replica. However, it's important to understand the basics of setting up SLP on OES 2. For more information, see “SLP” in the [OES 2 SP3: Planning and Implementation Guide](#).

- 1 Log in to the server as `root`.
- 2 Configure the server as an SLP DA server:
 - 2a Click *Computer > Home Folder*.
 - 2b In the left panel, double-click *File System*, then double-click the `etc` directory.
 - 2c Scroll down to the `slp.conf` file, right-click the file, and select *Open with gedit*.
 - 2d In `slp.conf`, find the following line:

```
;net.slp.useScopes = myScope1, myScope2, myScope3
```
 - 2e Remove the semicolon (`:`) and change the line as follows:

```
net.slp.useScopes = Directory
```

- 2f Find:

```
;net.slp.isDA = true
```

- 2g Remove the semicolon (`:`) so that it reads:

```
net.slp.isDA = true
```

- 2h** Save and close the file and the file browser.
- 3** Configure the firewall on the DA server to allow SLP daemon traffic:
 - 3a** Click *Computer > YaST Administrator Settings*, then click *Security and Users > Firewall*.
 - 3b** In the left navigation frame, click *Allowed Services*.
 - 3c** Click the *Services to Allow* drop-down list and select *SLP Daemon*.
 - 3d** Click *Add > Next*.
 - 3e** Click *Accept*.
- 4** Restart OpenSLP and eDirectory:
 - 4a** Click *Computer > Gnome Terminal*.
 - 4b** At the command prompt, enter the following command to restart the SLP daemon with the changed configuration:

```
rslpd restart
```
 - 4c** Restart eDirectory by entering the following command:

```
rcnstd restart
```

This registers eDirectory as an SLP service.
- 5** Verify that OpenSLP is running as expected.
 - 5a** After eDirectory restarts, enter the following command:

```
slptool findsrvs service:ndap.novell
```

After a moment or two, the system should respond with a line that indicates `EXAMPLE_TREE` is being advertised as a service in SLP.
 - 5b** Close the terminal by entering the following command:

```
exit
```
- 6** Continue with [Accessing iManager](#).

1.9 Accessing iManager

IMPORTANT: You must access iManager multiple times in this guide. If you get a Tomcat error in response to any launch requests, see [Section A.2, "iManager Tomcat Error," on page 111](#).

Novell iManager is the main browser-based tool you use to manage eDirectory and your OES 2 services.

To start iManager and prepare your browser for future sessions:

- 1** On your getting-started lab workstation, in your Web browser, open the OES 2 Welcome page by entering the following URL:

```
http://IP_or_DNS
```

where *IP_or_DNS* is the IP address or DNS name of your OES 2 server.

- 2** Click the *Management Services* tab.
- 3** On the Available Services page, click *iManager*.

You can also start iManager directly by including `/nps` after `IP_or_DNS` in the access URL. For example, enter `http://192.168.1.100/nps`.

- 4 You should receive a security alert, such as a warning that the connection is not trusted. Select the options to continue, such as *I Understand the Risks > Add Exception*.
- 5 Make sure that the option to permanently store the exception is selected if available, then confirm the exception.
- 6 Log in as the eDirectory Admin user:
 - 6a In the *Username* field, type `admin`.
 - 6b In the *Password* field, type the eDirectory Admin user password.
 - 6c In the *Tree* field, type `example_tree`.
If SLP services are not working properly, you need to enter the IP address instead of the tree name.
 - 6d Click *Login*.
- 7 Do not close iManager. Continue with the next section, [Configuring the Browser for the eDirectory CA](#).

1.10 Configuring the Browser for the eDirectory CA

If you didn't receive an offer to permanently store the security warning exception, you can configure your Web browser to trust the eDirectory-based certificate authority by completing the instructions in the next two sections. Otherwise, skip to [Section 1.11, "Enabling Pop-Ups for iManager," on page 23](#).

- ♦ [Section 1.10.1, "Exporting the CA's Self-Signed Certificate," on page 22](#)
- ♦ [Section 1.10.2, "Importing the CA Certificate into Mozilla Firefox 3.6 on Windows," on page 23](#)
- ♦ [Section 1.10.3, "Importing the CA Certificate into Windows Explorer 8 on Windows," on page 23](#)

1.10.1 Exporting the CA's Self-Signed Certificate

- 1 In iManager, click the *Roles and Tasks* icon .
- 2 Click *Novell Certificate Server > Configure Certificate Authority*.
- 3 Click the *Certificates* tab, then select the check box for the *self-signed certificate*.
- 4 Click the *Export* sub-tab.
- 5 Deselect *Export Private Key*.
The *Export Format* changes to DER.
- 6 Click *Next*.
- 7 Click *Save the Exported Certificate* and save the file to disk, noting the filename and location if indicated.
- 8 Click *Close > OK*.
- 9 Find the file you just saved. By default it is usually on the desktop.

- 10 To configure Mozilla Firefox on Windows, continue with [Importing the CA Certificate into Mozilla Firefox 3.6 on Windows](#).

Instructions for configuring other browsers are in “[Eliminating Browser Certificate Errors](#)” in the *OES 2 SP3: Planning and Implementation Guide*.

1.10.2 Importing the CA Certificate into Mozilla Firefox 3.6 on Windows

- 1 In Firefox, click *Tools > Options*
- 2 Select the *Advanced* tab.
- 3 Select the *Encryption* tab.
- 4 Click the *View Certificates* button.
- 5 Select the *Authorities* tab, then click *Import*.
- 6 Browse to the certificate file you downloaded in “[Exporting the CA’s Self-Signed Certificate](#)” on [page 22](#) and click *Open*.
- 7 Select *Trust this CA to identify Web sites*, then click *OK > OK > OK*.

Firefox now trusts certificates from the servers in your getting-started lab’s tree.

- 8 To verify success, close all instances of Firefox, then restart the browser and log in to iManager again.

The certificate warning doesn’t appear.

1.10.3 Importing the CA Certificate into Windows Explorer 8 on Windows

- 1 In Internet Explorer, click *Tools > Internet Options*.
- 2 Click the *Content* tab.
- 3 Click the *Certificates* button.
- 4 Select the *Trusted Root Certification Authorities* tab.
- 5 Click the *Import* button.
- 6 Click *Next*.
- 7 Browse to the certificate file you downloaded in “[Exporting the CA’s Self-Signed Certificate](#)” on [page 22](#) and click *Open*.
- 8 Click *Next*.
- 9 Click *Finish > Yes > OK > Close > OK*.

1.11 Enabling Pop-Ups for iManager

Some iManager plug-ins use pop-up dialog boxes that are blocked by most browsers. To use iManager, you must enable pop-ups that originate from the servers where iManager is running.

1.11.1 Firefox 3.6.x

- 1 On the Firefox menu bar, click *Tools > Options > Content*.
 - 2 Disable all pop-up blocking by deselecting the *Block Pop-up Windows* option and clicking *OK*.
- or

Add the getting-started lab server to the list of exceptions by doing the following:

2a Click the *Exceptions* button.

2b In the *Address of Web Site* field, type the OES 2 getting-started lab server's IP address.

2c Click *Allow > Close*.

1.11.2 Internet Explorer 8

1 On the Command bar, click *Tools > Pop-up Blocker > Turn Off Pop-up Blocker*.

Continue with [Chapter 2, "Installing a NetWare Virtual Machine,"](#) on page 25.

2 Installing a NetWare Virtual Machine

Use the instructions in this section to install an Open Enterprise Server 2 (OES 2) virtual machine host server in your getting-started lab, create a virtual machine on the server, and install NetWare® 6.5 SP8 on the virtual machine.

This section describes the following:

- ♦ [Section 2.1, “Virtualization Host Server Requirements,” on page 25](#)
- ♦ [Section 2.2, “Installing the Virtualization Host Server,” on page 26](#)
- ♦ [Section 2.3, “Installing the NetWare 6.5 SP8 Virtual Machine,” on page 34](#)

2.1 Virtualization Host Server Requirements

For the tasks and exercises described in this section, you need the following in addition to those listed in [Section 1.1, “Getting-started Lab Setup Requirements,” on page 9](#).

- A server-class computer with the following:

Component	Minimum	Recommended
Processor	Pentium II or AMD K7 450 MHz	Pentium III, Pentium III Xeon, Pentium 4, Intel Xeon 700 MHz, AMD K8 CPUs (Athlon64 and Opteron), Intel EM64T or higher processor
RAM	1 GB	2 GB
Display adapter	Super VGA	VESA 1.2-compliant, high resolution
DVD drive	Supports the EITorito Specification	
Hard drive	40 GB	
(All data will be erased)		
Network card	Ethernet 100 Mbps	

Component	Minimum	Recommended
IP address	<ul style="list-style-type: none"> ◆ Two IP addresses on the getting-started lab subnet (one for the OES 2 VM host and one for the NetWare VM). For example, 192.168.1.120 and 192.168.1.130. ◆ Subnet mask. For example, 255.255.255.0. ◆ Default gateway. For example, 192.168.1.1. 	
Mouse	Not required	USB or PS/2

- ❑ Installation software to match the processor type and removable media support of your VM host server.

If you need to download and prepare different media than you used for the first server, go to [Section 1.2, “Obtaining Installation Media,”](#) on page 10.

IMPORTANT: For installing the virtualized NetWare 6.5 SP8 guest server, you download the NetWare DVD ISO file to the VM host server desktop after the host server is installed and running.

2.2 Installing the Virtualization Host Server

Although it is possible to install NetWare 6.5 SP8 on a SUSE® Linux Enterprise Server (SLES) 10 SP4 server that has no OES 2 services installed, we recommend that you install the basic OES 2 services on the host server to provide backup services through SMS and management services through Novell® Remote Manager.

IMPORTANT: Virtualized NetWare in Xen* is an OES 2 product feature. Support of NetWare in a Xen virtual machine is available to only OES 2 registered customers.

Complete the instructions in the following sections.

- ◆ [Section 2.2.1, “Prerequisites,”](#) on page 27
- ◆ [Section 2.2.2, “Starting the Installation,”](#) on page 27
- ◆ [Section 2.2.3, “Setting the Root Password, Configuring the Network, and Updating the Server,”](#) on page 29
- ◆ [Section 2.2.4, “Configuring LDAP and OES Services,”](#) on page 32
- ◆ [Section 2.2.5, “Setting Up the Graphical User Interface,”](#) on page 33
- ◆ [Section 2.2.6, “Booting with the Xen Kernel,”](#) on page 34

2.2.1 Prerequisites

Before installing OES 2 on your server, you must complete the following task:

- ❑ Ensure that the server computer meets the requirements outlined in [Section 2.1, “Virtualization Host Server Requirements,”](#) on page 25.

2.2.2 Starting the Installation

WARNING: This procedure permanently erases any data currently on your server’s hard drive.

- 1 Prepare the BIOS on your server machine so that it will boot from the DVD drive first.
- 2 Insert the SLES 10 SP4 DVD into your server and reboot the machine.
- 3 When the boot selection page appears, immediately press the Down-arrow key to select the Installation option, then press Enter.
If you don’t respond before the machine starts booting from the hard disk, reboot and repeat this step.
- 4 After the boot process finishes, select an installation language, then click *Next*.
- 5 Read and agree to the software license agreement, then click *Next*.
- 6 Select *New Installation*, select the *Include add-on product from separate menu* option, then click *Next*.
- 7 On the Add-on Product Installation page, click *Add*.
- 8 Select *CD*, then click *Next*.
- 9 Insert the OES 2 SP3 CD as prompted.
- 10 After the catalog is added, read and agree to the OES 2 license agreement, then click *Next > Next*.
- 11 Select the time zone for the server, then click *Next*.
- 12 On the Installation Settings page, scroll down the list and click *Partitioning*.
If your server has existing partitions, the OES install tries to add new SLES partitions to them.
- 13 To ensure a clean install, use the following table to navigate and configure the partitioning pages:

Page Name	Action
Suggested Partitioning	<ol style="list-style-type: none">1. Select <i>Create Custom Partition Setup</i>.2. Click <i>Next</i>.
Preparing Hard Disk—Step 1	<ol style="list-style-type: none">1. Select <i>Custom Partitioning (for experts)</i>.2. Click <i>Next</i>.
Expert Partitioner	<ol style="list-style-type: none">1. Click <i>Expert > Delete partition table and disk label</i>.2. When prompted to select a new partition table type, click <i>OK</i>.
Caution!	<ol style="list-style-type: none">1. Click <i>Yes</i>.
Expert Partitioner	First, you specify the swap partition information. <ol style="list-style-type: none">1. Click <i>Create</i>.
Which type of partition do you want to create?	<ol style="list-style-type: none">1. Select <i>Primary partition</i>.2. Click <i>OK</i>.

Page Name	Action
Create a Primary Partition	<ol style="list-style-type: none"> 1. In the <i>File System</i> drop-down list, select <i>Swap</i>. 2. In the <i>End</i> field, type 512M. 3. Click <i>OK</i>.
Expert Partitioner	<p>Next, you specify information for the partition for installing the VM host server.</p> <ol style="list-style-type: none"> 1. Click <i>Create</i>.
Which type of partition do you want to create?	<ol style="list-style-type: none"> 1. Select <i>Primary partition</i>. 2. Click <i>OK</i>.
Create a Primary Partition	<ol style="list-style-type: none"> 1. In the <i>End</i> field, type 10GB. 2. Click <i>OK</i>.
Expert Partitioner	<ol style="list-style-type: none"> 1. Click <i>Create</i>.
Which type of partition do you want to create?	<ol style="list-style-type: none"> 1. Select <i>Primary partition</i>. 2. Click <i>OK</i>.
Create a Primary Partition	<p>And finally, you specify information for the partition where the NetWare virtual machine runs.</p> <ol style="list-style-type: none"> 1. In the <i>File System</i> drop-down list, select <i>Ext2</i>. Operating systems running in paravirtual mode should run their kernels on non-jouraling file systems, such as Ext2. For more information, see "Paravirtual Mode and Jouraling File Systems (http://www.novell.com/documentation/sles10/xen_admin/data/sec_xen_filesystem.html)" in the <i>Virtualization with XEN (http://www.novell.com/documentation/sles10/xen_admin/data/bookinfo.html)</i> guide. 2. In the <i>End</i> field, type 25GB. 3. In the <i>Mount Point</i> field, type <i>/vm</i>. 4. Click <i>OK</i>.
Expert Partitioner	<ol style="list-style-type: none"> 1. Click <i>Finish</i>.

14 On the Installation Settings page, scroll down and click *Software*.

Use the following table to navigate and configure the software pages.

Page Name	Action
Software Selection and System Tasks	<ol style="list-style-type: none"> Under OES Services, select <i>Novell Backup / Storage Management Services (SMS)</i>. Notice that <i>Novell Linux User Management</i> and <i>Novell Remote Manager</i> are also selected by default. These three are the only OES 2 services that are supported to run directly on a Xen virtualization host server. All OES 2 services are supported to run on Xen guest servers. Under <i>Primary Functions</i>, select <i>Xen Virtual Machine Host Server</i>. Click <i>Accept</i>.
agfa fonts	<ol style="list-style-type: none"> Click <i>Accept</i>.
Installation Settings	<ol style="list-style-type: none"> Click <i>Accept</i>.
Confirm Installation	<ol style="list-style-type: none"> Click <i>Install</i>.

- When prompted, insert the SLES media and click *Retry*.
Insert the DVD when you are prompted for CD1.
Insert additional media as instructed.
- After the files are copied, the system configuration takes a few minutes to complete.
- If you are prompted for additional input during the configuration, accept the default actions.
- Continue with [Setting the Root Password, Configuring the Network, and Updating the Server](#).

2.2.3 Setting the Root Password, Configuring the Network, and Updating the Server

After the initial system configuration and system reboot, the installation needs more information about the `root` user and the network.

- Use the following table to navigate and complete the various configuration pages.

Page Name	Action
Password for the System Administrator "root"	<ol style="list-style-type: none"> 1. Enter and confirm the <code>root</code> user password, then click <i>Next</i>.
Hostname and Domain Name	<ol style="list-style-type: none"> 1. In the <i>Host Name</i> field, type the DNS hostname for the IP address you are assigning to the server. For example, <code>myserver</code>. 2. In the <i>Domain Name</i> field, type the <i>DNS Domain Name</i> for your network. For example, <code>mysite.company.example.com</code>. 3. Click <i>Next</i>.
Network Configuration	<ol style="list-style-type: none"> 1. Click <i>Network Interfaces</i>.
Network Card Configuration Overview	<ol style="list-style-type: none"> 1. If your server has multiple network cards, select the card the server will use. 2. Click <i>Edit</i>. 3. Select <i>Static Address Setup</i>. 4. In the <i>IP Address</i> field, type the IP address for the server. For example, <code>192.168.1.120</code> 5. Change the <i>Subnet Mask</i> if needed. For example, <code>255.255.255.0</code>. 6. Click <i>Host Name and Name Server</i>.
Host Name and Name Server Configuration	<ol style="list-style-type: none"> 1. Type the IP address of at least one name server and type your DNS domain name in the <i>Domain Search</i> field. 2. Click <i>OK</i>.
Network Address Setup	<ol style="list-style-type: none"> 1. Click <i>Routing</i>.
Routing Configuration	<ol style="list-style-type: none"> 1. Type the IP address of the default gateway for your getting-started lab subnet. For example, <code>192.168.1.1</code>. 2. Click <i>OK</i>.
Network Address Setup	<ol style="list-style-type: none"> 1. Click <i>Next</i>.
Network Card Configuration Overview	<ol style="list-style-type: none"> 1. Click <i>Next</i>.
Network Configuration	<ol style="list-style-type: none"> 1. Click <i>Next</i>.
Test Internet Connection	<p>You will need to register your server on the Internet to download the latest patches, so you should test the Internet connection at this point to make sure everything is configured correctly.</p> <ol style="list-style-type: none"> 1. Select <i>Yes, Test Connection to the Internet</i>. 2. Click <i>Next</i>.
Running Internet Connection Test	<p>After a few moments, the <i>Test Status</i> should indicate <i>Success</i>.</p> <p>If it does not, you need to click <i>Back</i> and fix your network configuration and the connection to the Internet. It is essential that OES 2 servers always have the latest security and other critical patches downloaded and installed.</p> <ol style="list-style-type: none"> 1. Click <i>Next</i>.

Page Name	Action
Novell Customer Center Configuration	<ol style="list-style-type: none"> Click <i>Next</i>. The server establishes a connection with the Novell Customer Center.
Manual Interaction Required	<ol style="list-style-type: none"> Click <i>Continue</i>.
Novell Customer Center System Registration	<ol style="list-style-type: none"> In the fields indicated, type and confirm the e-mail address to which you want administrative notifications sent. In the <i>Activation code for SLES components</i> field, type the SLES activation code you noted or printed while downloading the image files. IMPORTANT: If you don't enter this code, the server cannot receive software updates from the Novell patch channels and your installation of OES 2 SP3 will fail. In the <i>Activation code for OES components</i> field, type the OES 2 activation code you noted or printed while downloading the image files. If you don't enter this code, the same patch channel restriction applies. Click <i>Submit</i>. Your registration information is sent to the Customer Center. This might take a couple of minutes to complete. Click <i>Continue</i>. The update server is added to your system configuration.
Novell Customer Center Configuration pop-up	<ol style="list-style-type: none"> Click <i>OK</i>.
Online Update	<p>You might need to run the update process more than once.</p> <ol style="list-style-type: none"> Select <i>Run Update</i>, then click <i>Next</i>. Although you might need to scroll down to see them, the correct patches are automatically selected. Do not change the selections. Click <i>Accept</i>. If one or more notification dialog boxes appear, accept or continue through each one. Insert additional installation media as instructed. The security and other critical patches and updates are downloaded and installed. The update patches are downloaded and installed. When both status bars indicate <i>100%</i>, click <i>Next > OK</i>. If the system refreshes with additional patches selected, apply them as well. When both status bars indicate <i>100%</i>, click <i>Next > OK</i>. The system restarts.
Installation Settings	<p>Notice the red text under CA Management. This is because the system restarted and the installation no longer has the <code>root</code> password in memory.</p> <ol style="list-style-type: none"> Click <i>CA Management</i>.

Page Name	Action
Managing CAs and Certificates	1. Click <i>Edit Default Settings</i> .
Edit Default Settings	1. Type the <code>root</code> password in the <i>Password</i> and <i>Confirm Password</i> fields, then click <i>Next</i> .
Managing CAs and Certificates	1. Click <i>Next</i> .
Installation Settings	1. Click <i>Next</i> .

2 Continue with [Configuring LDAP and OES Services](#)

2.2.4 Configuring LDAP and OES Services

The VM host server is not created as an object in eDirectory™, but it uses eDirectory LDAP for the OES 2 services installed on it.

1 Use the following table to navigate and complete the eDirectory pages:

Page Name	Action
Configured LDAP Servers	<ol style="list-style-type: none"> 1. In the <i>eDirectory Tree Name</i> field, type <code>EXAMPLE_TREE</code>. 2. In the <i>Admin User and Context</i> field, type <code>cn=admin.o=company</code>. 3. In the <i>Admin Password</i> field, type the admin password. 4. Under the <i>Configured LDAP Servers</i> list, click <i>Add</i>. 5. Specify the IP address of the first getting-started lab server. 6. Click <i>Add > Next</i>. 7. Click <i>Next</i>.
Novell Open Enterprise Server Configuration	<ol style="list-style-type: none"> 1. Click <i>Next</i>. <p>The configuration settings are saved for the OES services you've installed.</p>
User Authentication Method	<ol style="list-style-type: none"> 1. Click <i>Next</i>.
New Local User	<p>The <code>root</code> user was created during the SLES install. On OES 2 servers (including virtualization host servers), we recommend that all users except <code>root</code> be defined in eDirectory. Therefore, you don't create additional local users.</p> <ol style="list-style-type: none"> 1. Click <i>Next</i>.
Empty User Login	<ol style="list-style-type: none"> 1. Click <i>Yes</i>.
Release Notes	<ol style="list-style-type: none"> 1. Click <i>Next</i>. <p>The official OES 2 Release Notes (http://www.novell.com/documentation/oes2/oes_readme/data/readme.html) are published with the OES 2 Online Documentation (http://www.novell.com/documentation/oes2).</p>

2 Continue with [Setting Up the Graphical User Interface](#).

2.2.5 Setting Up the Graphical User Interface

When the Hardware Configuration page appears:

- 1 Review the Graphics Cards configuration to make sure your monitor was detected and that your color and resolution settings are the way you want them.
If the settings are correct, skip to [Step 3](#).
- 2 (Conditional) If the configuration is incomplete or wrong, click the blue links to configure your monitor, color, resolution, etc.
- 3 Click *Next*.

- 4 When the *Installation Completed* page appears, deselect *Clone This System for Autoyast* and click *Finish*.
- 5 Continue with [Booting with the Xen Kernel](#).

2.2.6 Booting with the Xen Kernel

By default, the OES 2 server doesn't load the Xen kernel required for hosting virtual machines. To configure the server to boot the Xen kernel by default:

- 1 Log in to the server as root.
- 2 On the desktop, click *Computer > YaST*.
- 3 Click *System > Boot Loader*.
- 4 Select the *XEN* option and click *Set as Default*.
- 5 Click *Finish*.
- 6 Restart the server by clicking *Computer > Log Out > Log Out*. Then click *Reboot* and enter the root password.
- 7 Continue with [Installing the NetWare 6.5 SP8 Virtual Machine](#).

2.3 Installing the NetWare 6.5 SP8 Virtual Machine

After preparing the virtualization host server, complete the following instructions. For complete information and instructions, see the [Novell Virtualization Technology documentation Web site \(http://www.novell.com/documentation/vmserver/index.html\)](http://www.novell.com/documentation/vmserver/index.html).

- ♦ [Section 2.3.1, "Disabling the Alt+Esc Shortcut on the VM Host Server," on page 34](#)
- ♦ [Section 2.3.2, "Downloading the NetWare ISO File," on page 35](#)
- ♦ [Section 2.3.3, "Creating a Virtual Machine and Installing NetWare," on page 35](#)

2.3.1 Disabling the Alt+Esc Shortcut on the VM Host Server

Alt+Esc is used on a NetWare server to switch between console screens, but on SLES 10 it moves between open windows. To provide the expected behavior for the virtualized NetWare server, you must disable the shortcut for SLES 10.

- 1 On the host server as the root user, click *Computer > Control Center*.
- 2 Click *Personal > Shortcuts*.
- 3 Under the *Window Management* category, click *Move between windows immediately*, then press the Backspace key to disable the shortcut.
- 4 Click *Close*.
- 5 Close the Control Center.
- 6 Continue with [Downloading the NetWare ISO File](#).

2.3.2 Downloading the NetWare ISO File

You install NetWare from the DVD `.iso` file copied to the server's hard drive.

- 1 On the host server, click *Computer > Firefox* and access the [NetWare 6.5 SP8 e Media Kit on the Novell Download Web site \(http://download.novell.com/Download?buildid=dpIR3H1ymhk~\)](http://download.novell.com/Download?buildid=dpIR3H1ymhk~).
- 2 On the evaluation page, click *Proceed to Download*.
- 3 Log in using your Novell Account information.
- 4 Click the *Download* button for the `NW65SP8_OVL_DVD.iso` file.
- 5 Select *Save to Disk* and click *OK*.

The file is saved to the desktop.

- 6 After the file downloads, verify its integrity.
 - 6a Click *Computer > Gnome Terminal*.
 - 6b At the command prompt, enter `cd Desktop`.

The terminal opens in the `root` user's home directory (`/root`). The desktop is contained in a subfolder of `/root` named `Desktop`.
 - 6c Check the MD5 checksum value of the downloaded image file by entering:

```
md5sum NW65SP8_OVL_DVD.iso
```
 - 6d Compare the displayed value against the value listed on the evaluation download page.

If the values don't match, you must download the file again until you get a matching checksum.
 - 6e Close the terminal by entering `exit`.
 - 6f You can also close the browser and the download dialog box.
- 7 Continue with [Creating a Virtual Machine and Installing NetWare](#).

2.3.3 Creating a Virtual Machine and Installing NetWare

- 1 On the desktop, click *Computer > YaST*.
- 2 Select *Virtualization > Virtual Machine Manager*.

Notice that one virtual machine, *Domain-0* (the OES 2 virtual machine host server) is already running.
- 3 Use the information in the following table to create a second virtual machine and start the NetWare installation.

Page Name	Action
Virtual Machine Manager	<ol style="list-style-type: none">1. In the list of virtual machines, select the <i>localhost</i> entry.2. Click <i>New</i>.<p>The Create a Virtual Machine Wizard launches.</p>
Create a Virtual Machine	<ol style="list-style-type: none">1. Click <i>Forward</i>.
Install an Operating System?	<ol style="list-style-type: none">1. Click <i>Forward</i>.

Page Name	Action
Type of Operating System	<ol style="list-style-type: none"> 1. Click the expand icon next to <i>NetWare</i>, then select <i>Novell Open Enterprise Server 2 (NetWare)</i>. 2. Click <i>Forward</i>.
Summary	<ol style="list-style-type: none"> 1. Click <i>Name of Virtual Machine</i>.
Name of Virtual Machine	<ol style="list-style-type: none"> 1. In the <i>Name</i> field, type <code>LAB_NW_VM</code>. It is easier to know which VM you are managing if it reflects the name of the server it contains. 2. Click <i>Apply</i>.
Summary	<ol style="list-style-type: none"> 1. Click <i>Hardware</i>.
Hardware	<ol style="list-style-type: none"> 1. If your server has more than 1 GB memory installed, increase the initial memory allocated to the VM by clicking the arrows. For example, if your server has 2 GB memory installed, you can easily increase the initial memory amount to 1024 MB. 2. Click <i>Apply</i>.
Summary	<ol style="list-style-type: none"> 1. Click <i>Disks</i>.
Disks	<p>Initially, a 10 GB file is specified for the partitions/volumes on the virtual server. By default, this is a sparse file, meaning that although 10 GB is allocated, the size of the file on the disk will only be as large as the actual data it contains. Sparse files conserve disk space, but they have a negative impact on performance.</p> <p>The NetWare install allocates 500 MB for a DOS partition and 8 GB for the SYS: volume. The default disk size of 10 GB leaves about 1.5 GB for other partitions, which isn't very much, although it is sufficient for the exercises in this guide.</p> <p>However, you allocated 25 GB for the /vm mount point on the server, so let's allocate all of that to this virtual machine.</p> <ol style="list-style-type: none"> 1. With the default <i>Hard Disk</i> selected, click <i>Edit</i>. 2. Modify the path in the <i>Server</i> field to be <code>file:/vm/LAB_NW_VM/disk0</code> This creates the virtual machine files on the Ext2 /vm partition you created during the installation. 3. In the <i>Size</i> field, replace 10.0 with 25. 4. Deselect <i>Create Sparse Image File</i>. This dedicates 25 GB of physical disk space on the file system to the VM file and improves performance of the Virtual NetWare server. 5. Click <i>OK</i>. 6. Click <i>CD-ROM</i>. 7. Click <i>Browse</i>, then navigate to and select the <code>NW65SP8_OVL_DVD.iso</code> file you downloaded to the desktop. 8. Click <i>Open</i>. 9. Click <i>OK</i>. 10. Click <i>Apply</i>.

Page Name	Action
Summary	<ol style="list-style-type: none"> Click <i>OK</i>. <p>The virtual machine is created and the NetWare installation starts.</p> <p>This can take a few minutes or longer, depending on processor speed, memory, etc. Most of the time is required to prepare the 25 GB VM file. However, after the file is prepared, the VM will run much more efficiently than if it were using a sparse file.</p>

- 4 After the NetWare installation starts, use the following table to navigate the pages listed in the left column:

IMPORTANT: Some of the instructions that follow assume you have a mouse attached to the server. If not, as you install, use the Tab key to select the options indicated, then press Enter to continue.

Page Name	Action
NetWare Installation	<ol style="list-style-type: none"> Click inside the installation window to set the mouse pointer. <p>The mouse is not used on the first few screens, but you must set it now. Otherwise, the mouse and the keyboard might not work as expected when the GUI pages appear.</p> Use the arrow keys to select a language, then press Enter. Modify the Regional Settings if desired, then select <i>Continue</i> and press Enter. Press F10 twice to accept the license agreements. Press the Down-arrow key to select <i>Continue</i>, then press Enter. Press Enter to <ul style="list-style-type: none"> ◆ Create an 8 GB SYS: volume. ◆ Begin copying files for the installation. <p>As the files copy, notice the <i>Run</i>, <i>Pause</i>, and <i>Shutdown</i> options above the window displaying the installation. After the server is installed, they are activated, and you can then use them to manage the state of the virtual machine.</p>
Choose a Pattern	<ol style="list-style-type: none"> Click <i>Next</i>. <p>At the start of the installation you set the mouse pointer inside the window boundary. To free the mouse to move outside the window, press Ctrl+Alt. To start working in the window again, click inside it to set the pointer.</p>
Components	<ol style="list-style-type: none"> Select <ul style="list-style-type: none"> ◆ <i>Apache 2 Web Server and Tomcat 4 Servlet Container</i> ◆ <i>Tomcat 5 Servlet Container</i> ◆ <i>Novell iManager 2.7.2</i> Click <i>Next</i>.

Page Name	Action
Novell iManager 2.7.2	1. Click <i>Yes</i> .
Summary	1. Click <i>Copy Files</i> .
Server Properties	1. Type <code>LAB_NW</code> for the server name. 2. Click <i>Next</i> .
Protocols	1. Click <i>IP</i> . The installation process accesses the server. 2. Click the first <i>IP Address</i> field, then type the IP address of the server. For example, 192.168.1.130. 3. Type the subnet mask for the address. For example, 255.255.255.0. 4. Type the router (gateway) address for the subnet. For example, 192.168.1.1. 5. Click <i>Advanced</i> .
Advanced	1. Click the <i>SLP</i> tab. 2. In the <i>DA Server 1</i> field, type the IP address of the SLP Directory Agent (DA), which is the first OES 2 server you installed in the getting-started lab. For example, 192.168.1.100. 3. In the <i>SLP Scope List</i> field, type <i>Directory</i> . 4. Click <i>OK</i> .
Protocols	1. Click <i>Next</i> .
Domain Name Service	1. Type the DNS hostname associated with the IP address you just entered. In contrast to OES 2 servers, this can be different than the name used in eDirectory. Of course, you can choose to use the DNS name for NetWare servers in eDirectory in your production network. In this guide, however, the eDirectory server name is assumed to be <code>LAB_NW</code> . 2. Type the domain name. 3. Type at least one DNS name server IP address. For example, 192.168.1.50. 4. Click <i>Next</i>
Time Zone	1. Click the correct time zone for your area. 2. Click <i>Advanced</i> .
Time Synchronization	1. Leave the protocol set to <i>Timesync</i> . 2. Click <i>Use Configured Sources</i> . 3. In the <i>Time Source 1</i> field, type the IP address of the same reliable time source you specified for the OES 2 getting-started lab server (not the VM host server). 4. Select <i>NTP</i> . 5. Click <i>OK</i> . 6. Click <i>Next</i> .
eDirectory Installation	1. Click <i>Next</i> .

Page Name	Action
eDirectory Information	<ol style="list-style-type: none"> 1. Click the <i>Tree</i> icon. 2. Browse to and select <i>EXAMPLE_TREE</i>. 3. Click <i>OK</i>. 4. Click the browse icon to the right of the <i>Context for Server Object</i> field. 5. Browse to and select <i>SERVERS</i> (in <i>COMPANY > LAB</i>). 6. Click <i>OK</i>. 7. Click <i>Next</i>.
eDirectory Login	<ol style="list-style-type: none"> 1. Click the browse icon to the right of the <i>Name</i> field. 2. Browse to and select <i>admin</i> (in <i>COMPANY</i>). 3. Click <i>OK</i>. 4. Type the Admin user's password. 5. Click <i>OK</i>.
NDS/eDirectory Patch Detection	<p>The warning doesn't apply because you are installing into an eDirectory 8.8 tree.</p> <ol style="list-style-type: none"> 1. Click <i>OK</i>. <p>The system checks time synchronization, extends the eDirectory schema, and installs an eDirectory replica on the virtualized NetWare server.</p>
eDirectory Summary	<ol style="list-style-type: none"> 1. Click <i>Next</i>.
Licenses	<p>In this page you install the license included with NetWare 6.5 SP8. The software license doesn't expire, but your evaluation period expires 90 days after you install the server. At that point you should either uninstall NetWare or purchase the OES 2 product. For more information, see "NetWare 6.5 SP8 Includes MLA License Files" in the <i>NW 6.5 SP8: Licensing Services Administration Guide</i>.</p> <ol style="list-style-type: none"> 1. Click the <i>Browse</i> icon to the right of the <i>License Location</i> field. 2. In the <i>Select a License</i> dialog box, click the expansion dots to the left of <i>NW65OS</i> and then the dot to the left of <i>LICENSE</i>. 3. Click the <i>NLF</i> file that appears in the right frame. 4. Click <i>OK</i>. 5. Click <i>Next</i>.
MLA License Certificate Context	<ol style="list-style-type: none"> 1. Change the <i>NDS Context</i> for the license file to <i>O=COMPANY</i>. This makes this license available to any additional NetWare 6.5 servers you might choose to install in a different context in the tree, including any physical NetWare servers you install. 2. Click <i>Next</i>.

Page Name	Action
Novell Modular Authentication Service	<p>1. Click <i>Next</i>.</p> <p>It takes a few minutes for the installation to configure your OES 2 services. If you want to learn more about various OES 2 services (most of which we have not installed), you can read the information pages as the configuration process runs.</p> <p>You can install more services later if you want to experiment further.</p>
Reset Your Server Now?	1. Click <i>Yes</i> .

- 5 Close the Virtual Machine Manager windows by clicking the X on the upper right corner, or by right-clicking the title bar and selecting *Close*. The NetWare server continues to run.

IMPORTANT: It is wise to keep Virtual Machine Manager open only while you are actively using it to manage the virtual machines on your host server. Otherwise, the manager incrementally consumes domain 0 memory and eventually causes out-of-memory errors. For more information, see “[Virtual Machine Manager \(http://www.novell.com/documentation/sles10/xen_admin/data/sec_xen_virtualization_vmanager.html\)](http://www.novell.com/documentation/sles10/xen_admin/data/sec_xen_virtualization_vmanager.html)” in the *Virtualization with Xen Guide* (http://www.novell.com/documentation/sles10/xen_admin/data/bookinfo.html) guide.

- 6 Continue with [Chapter 3, “eDirectory, Users and Groups, and Identity Services,”](#) on page 41.

3 eDirectory, Users and Groups, and Identity Services

Novell® eDirectory™ is the central, key component of Novell Open Enterprise Server (OES). It provides the following:

- ♦ Centralized identity management
- ♦ The underlying infrastructure for managing your network servers and the services they provide
- ♦ Secure access to network services both within the firewall and from the Web

The installation steps presented in this guide thus far have created a new eDirectory tree named EXAMPLE_TREE that you are using to learn about OES 2. As you work with the tree and the objects it contains, you will begin to better understand the role eDirectory plays.

This section discusses the following:

- ♦ [Section 3.1, “Using the eDirectory Information in This Guide,” on page 41](#)
- ♦ [Section 3.2, “An Introduction to eDirectory Planning,” on page 42](#)
- ♦ [Section 3.3, “Setting Up Role-Based Services,” on page 45](#)
- ♦ [Section 3.4, “Updating the iManager Plug-in Modules,” on page 46](#)
- ♦ [Section 3.5, “Creating a Context for Your Users and Groups,” on page 46](#)
- ♦ [Section 3.6, “Assigning a Password Policy to Your Users,” on page 47](#)
- ♦ [Section 3.7, “Creating NCP and NSS Volumes for Home Directories,” on page 48](#)
- ♦ [Section 3.8, “Creating Users,” on page 51](#)
- ♦ [Section 3.9, “A Note about Identity Manager 3.6 Bundle Edition,” on page 54](#)

3.1 Using the eDirectory Information in This Guide

Before you install OES 2 in a production environment, it is critical that you and your organization take time to plan and design your tree.

However, the instructions in this guide require no planning on your part. In fact, most of the eDirectory objects needed for the exercises in this guide were created in [Chapter 1, “Installing the OES 2 SP3 Server in Your Getting-started Lab,” on page 9](#).

The information that follows introduces eDirectory.

If you are already familiar with eDirectory and want to skip the planning introduction, we recommend that you do the following:

1. View the eDirectory tree structure used in this guide ([Figure 3-1 on page 42](#)).
2. Skip to [Section 3.4, “Updating the iManager Plug-in Modules,” on page 46](#).

3.2 An Introduction to eDirectory Planning

If you want an efficient and intuitive eDirectory design, you and your organization need to base it on two things:

- ♦ The layout of your network
- ♦ The structure of your organization

You and your team should carefully think through the issues and design considerations discussed in “[Designing Your Novell eDirectory Network](#)” in the *Novell eDirectory 8.8 Administration Guide*.

- ♦ [Section 3.2.1, “Your Getting-started Lab’s eDirectory Tree,”](#) on page 42
- ♦ [Section 3.2.2, “Your Current Getting-started Lab Tree,”](#) on page 43
- ♦ [Section 3.2.3, “Expanding Your Getting-started Lab Tree,”](#) on page 44

3.2.1 Your Getting-started Lab’s eDirectory Tree

[Figure 3-1](#) illustrates an eDirectory tree like the one you will use in the getting-started lab exercises found in this guide. It also illustrates and explains the basic elements you should consider when designing an eDirectory tree.

NOTE: The IS Organizational Unit object is included for explanatory purposes and is not created in this guide.

Figure 3-1 Your Getting-started Lab’s eDirectory Tree

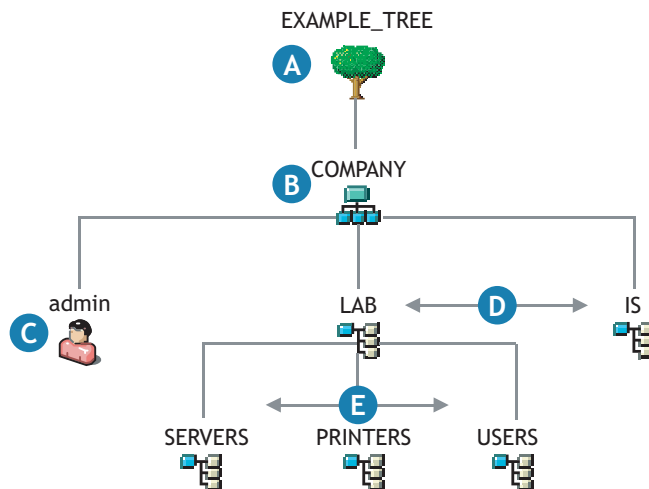

Reference Letter	Explanation
A	The Tree object is the top container object in the tree. It usually contains an Organization object (specified in the install by using o=company) that represents your company or organization.
B	<p>The Organization object is normally the first (and often the only) container object under the Tree object. It is typically named after your organization.</p> <p>Small organizations keep object management simple by having all other objects, such as users, printers, and servers, directly under the Organization object.</p> <p>Organizations that are large enough to have departments or other organizational units usually decide to have their tree structure reflect their organizational structure.</p> <p>As shown in this getting-started lab example, these organizations create Organizational Unit objects (specified during the install by using ou=name) that reflect their departments, divisions, geographical locations, etc., as is logical for their organization.</p> <p>Sometimes large organizations create multiple Organization objects below the Tree object to represent separate business units or subsidiaries.</p>
C	Every tree requires an Admin User object. You will log in as Admin to create or import other User objects and to create the rest of your tree structure.
D	This example shows two Organizational Unit objects at the department level (LAB and IS).
E	This example also illustrates how Organizational Unit objects can be nested to provide a complex hierarchy if it is necessary to manage the organization.

3.2.2 Your Current Getting-started Lab Tree

The eDirectory tree you have created by installing OES 2 in your getting-started lab is illustrated by the darker objects in [Figure 3-2](#). The objects that are dimmed are for explanatory purposes and do not exist in your current tree. When you finish with this guide, the upper level organization of your tree will look more like [Figure 3-1](#), except that the IS Organizational Unit shown in that illustration will not be created.

Figure 3-2 Your Current Getting-started Lab Tree

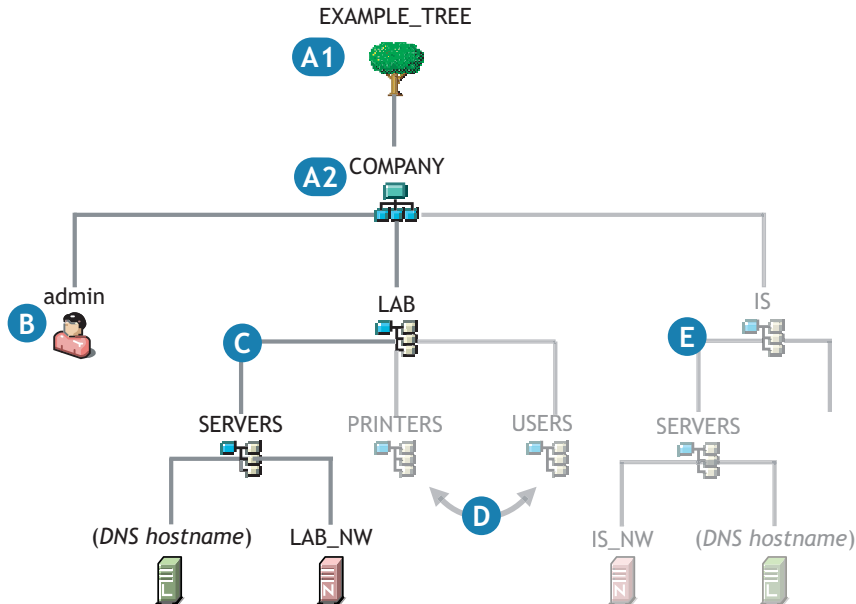

Reference Letter

Explanation

- A** The OES installation process requires that you specify names for the following objects:
 - ◆ **A1:** A Tree object
 - ◆ **A2:** An Organization object
- B** One of the first objects you specify during an initial installation is the Admin user.
- C** The OES installation process can also create Organizational Unit (OU) objects to define a context for the OES 2 Server object.
- D** All other OU objects that you have planned for your tree must be created after the installation finishes. For example, you will create the PRINTERS and USERS OU objects later in this guide.
- E** The exception to D is that subsequent installations can create additional contexts to contain other OES servers that you install into the tree. For example, you could create a SERVERS OU under the IS OU as illustrated.

3.2.3 Expanding Your Getting-started Lab Tree

The instructions in this guide cover only the installation of an OES 2 and a virtualized NetWare® 6.5 SP8 server in the tree.

If you were to decide to install additional servers in the tree, the processes you would follow could involve some additional planning tasks, as illustrated in [Figure 3-3](#).

Figure 3-3 An Expanded Tree

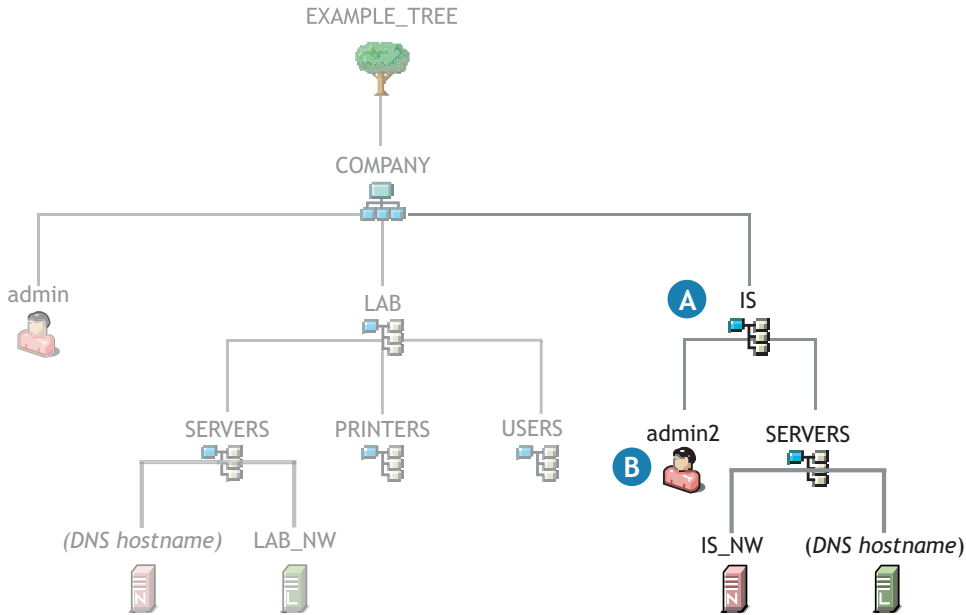

Reference Letter

Explanation

- A** During subsequent installations into the same tree, you can create new Organizational Unit objects to provide a context for other OES 2 servers being installed.
- B** If you want to specify other Admin users in the OES 2 installation parameters, you can do this during the installation. Note, however, that such an Admin would probably not be granted rights to the entire tree, only to the objects under the IS OU. Admin objects like this are often referred to as sub-container admins.

3.3 Setting Up Role-Based Services



When iManager is installed in connection with OES 2, the administrative tasks available through the *Roles and Tasks* icon are available to all users until you run the configuration wizard. In this exercise, you create a Role-Based Services (RBS) collection that contains all of the management roles in the tree.

When the installation process finishes as outlined below, the eDirectory Admin user is the only user configured to perform the administrative tasks available through the Roles and Tasks icon. If you want to create other administrative users and assign them a subset of administrative roles, you need to create additional collections with subsets of roles and assign the other administrative users to them. For more information, see [“Configuring and Customizing iManager”](#) in the *Novell iManager 2.7.4 Administration Guide*.

- 1 At your Windows workstation, log in to iManager on the OES 2 getting-started lab server, using the eDirectory Admin user account and password. For more information, see the steps in [Section 1.9, “Accessing iManager,”](#) on page 21.

If you receive a Tomcat error, see [Section A.2, “iManager Tomcat Error,”](#) on page 111.

- 2 Click the *Configure* icon .

- 3 Select *Role Based Services > RBS Configuration*.
- 4 Click *iManager 2.x collections > New > Collection and Setup*.
- 5 If you are prompted to extend the schema, click *Next*.
- 6 In the *Name* field, type the following:
Tree Admin Role
- 7 Click the *Browse* icon  next to the *Container* field.
- 8 Click *COMPANY*, then click *Next*.
- 9 Click the *Browse* icon  next to the *Scope* field.
- 10 Click *EXAMPLE_TREE*.
- 11 Click *Start*.
- 12 Do not close iManager. After the operation finishes, continue with the next section, [Updating the iManager Plug-in Modules](#).

3.4 Updating the iManager Plug-in Modules



- 1 In the *Configure* pane, click *Plug-in Installation > Available Novell Plug-in Modules*.
A list shows the plug-ins on novell.com that have been updated or created since OES 2 was initially released.
- 2 Click the check box in the header row.
All of the available plug-in modules are selected.
- 3 Click *Install*.
- 4 Agree to the license agreement and click *OK*.
- 5 When the plug-in installation process concludes, click *Close*.
You can safely ignore plug-in installation errors in connection with the exercises in this guide. If you have concerns about the errors for production servers, contact Novell support or visit the [Novell Support Web page \(http://support.novell.com\)](http://support.novell.com).
- 6 Do not close iManager. Continue with the next section, [Creating a Context for Your Users and Groups](#).

3.5 Creating a Context for Your Users and Groups

All OES 2 services require that you create User objects to represent the users on your system. The Linux User Management component for OES 2 servers requires that you also create a Group object that you can assign the users to.

If you reviewed [Section 3.2, “An Introduction to eDirectory Planning,” on page 42](#), you might have noticed an Organizational Unit object named USERS in [Figure 3-2](#) and [Figure 3-3](#). It is helpful to have at least one Organization Unit object to contain user-related objects, such as User objects and Group objects.

To create an Organizational Unit container object named USERS in the LAB Organizational Unit object:



- 1 In iManager, click the *View Objects* icon .
- 2 In the left pane, click the *Browse* tab.
- 3 Click the down-arrow  next to the *COMPANY* Organization object .
- 4 Click *LAB*, then select *Create Object* from the drop-down list.
- 5 From the *Available Object Classes* list, select *Organizational Unit*, then click *OK*.
- 6 In the *Organizational Unit name* field, type *USERS*.
- 7 Click *OK > OK*.
- 8 Do not close iManager. Continue with the next section, [Assigning a Password Policy to Your Users](#).

3.6 Assigning a Password Policy to Your Users

Beginning with OES 2 SP3, the configuration of proxy users and universal password policies is simplified by default. In [“Configuring eDirectory and OES Services” on page 17](#) you created a common proxy user, and a universal password policy named Common Proxy Policy.

In order for the users you create to use some of the OES services you have installed, such as Novell CIFS, you must associate the Common Proxy Policy with those users. The simplest method for doing this is to associate the policy with the *USERS* container created in [Section 3.5, “Creating a Context for Your Users and Groups,” on page 46](#).

NOTE: The Common Proxy Policy is associated with the server’s parent container (*SERVERS*) by default. If your users were in the same container as the server or in a subcontainer of it, then the following steps would not be needed. However, the *USERS* container is a sibling to the *SERVERS* container in the tree created in this guide.

- 1 In iManager, click the *Roles and Tasks* icon .
- 2 Click *Passwords > Password Policies*.
- 3 Click the *Common Proxy Policy* link.
- 4 Click the *Policy Assignment* tab.
- 5 Click the *Browse* icon  next to the *Assign To* field.
- 6 In the *Contents* pane, browse to the *LAB* Organizational Unit.
- 7 Select the *USERS* Organizational Unit object, then click *OK*.
- 8 Click *Apply > OK*.
- 9 Do not close iManager. Continue with the next section, [Creating NCP and NSS Volumes for Home Directories](#).

3.7 Creating NCP and NSS Volumes for Home Directories

For the exercises in the guide, you need home directories for the users you create.

When you create NCP™ and NSS volumes before creating users, you can then create home directories at the same time as you create the user objects. For that reason, it makes sense to set up the volumes prior to user object creation.

- ♦ [Section 3.7.1, “Home Directories on OES 2,” on page 48](#)
- ♦ [Section 3.7.2, “Home Directories on NetWare 6.5,” on page 50](#)
- ♦ [Section 3.7.3, “Summary of Getting-started Lab Home Directories and Purposes,” on page 51](#)

3.7.1 Home Directories on OES 2

On OES 2, home and other data directories can reside in three possible volume types, each of which is presented in this guide. The volume types are:

- ♦ **Linux POSIX volumes:** Your OES 2 getting-started lab server already contains a / (root) partition with an empty /home directory (the default location for home directories on Linux servers).
- ♦ **NCP volumes that point to Linux POSIX volumes:** Your OES 2 server has NCP Server installed so you can create NCP volumes that point to the Linux POSIX* file systems.
- ♦ **Novell Storage Services (NSS) volumes:** Your OES 2 server is prepared with EVMS to support NSS volumes. (NSS is the native file system on NetWare.)

There are important differences between the home directories in each of these locations and in the configuration steps required to create them and set the needed file/directory trustee assignments, etc.

- ♦ [“The Linux POSIX /home Directory” on page 48](#)
- ♦ [“Creating an NCP Volume on the OES 2 Server” on page 49](#)
- ♦ [“Creating an NSS Pool and Volume on the OES 2 Server” on page 49](#)

The Linux POSIX /home Directory

For the exercises in this guide, you create POSIX home directories for two users. This lets you easily see the differences between directories created through POSIX and directories created through NCP. Both directory types exist on the same physical disk space and are displayed as POSIX home directories, but only the NCP directories appear in NCP interfaces.

Creating an NCP Volume on the OES 2 Server

OES 2 lets you create NCP volumes that point to directories on the Linux POSIX partitions of your server. For the exercises in this guide, you create an NCP volume that points to the `/home` directory on your server. NCP volumes support the Novell File and Directory Trustee Rights model when files are accessed through an NCP client.

NCP volumes on Linux POSIX file systems differ from NSS volumes; NCP volumes do not support NSS file attributes, such as Delete Inhibit. For more information, see “[Directory and File Attributes](#)” in the *OES 2 SP3: NCP Server for Linux Administration Guide*.



- 1 Log into your server as `root` and click *Computer > Gnome Terminal*.
- 2 Create an NCP volume in NCPCON that points to the `/home` directory by entering the following commands:

```
ncpcon create volume home_ncp /home
exit
```

Creating an NSS Pool and Volume on the OES 2 Server

OES 2 supports NSS volumes. NSS is a fast-mounting, journaled file system for OES 2 and NetWare. It is the only file system in the industry that is integrated with identity management. NSS volumes support the Novell File and Directory Trustee Rights model and also NSS file attributes. For more information, see “[The Traditional Novell Access Control Model](#)” in the *OES 2 SP3: Planning and Implementation Guide*.

NSS volumes can span partitions and even hard disks. For a graphical overview of NSS volumes, see [Section A.1, “NSS Partitions, Pools, and Volumes,”](#) on page 109.

- 1 On your getting-started lab workstation in iManager, click the *Roles and Tasks* icon .
- 2 Click *Storage > Pools*.
- 3 Click the *Browse* icon  next to the *Server* field,
- 4 Browse to and select your OES 2 getting-started lab server object (in *COMPANY > LAB > SERVERS*).
- 5 Click *New*.
- 6 Name the pool `pool_lx` and click *Next*.
- 7 Click the box next to the system disk in your server (`sda`, `hda`, etc.).
- 8 By default, all of the free space on the disk should be automatically entered in the *Used Size* field, and the amount should match the *Free Size (MB)* displayed to the right of the system disk. If the *Used Size* field is blank, type the free space amount.
- 9 Click *Finish*.

POOL_LX is listed as an available pool. Notice that the NSS pool name is uppercase, even though you typed lowercase. All NCP and NSS volumes, are created and displayed in uppercase to give a visual distinction from the Linux POSIX lowercase norm, to prevent visual confusion of letters and numbers (`vol1` vs. `VOL1`), and because names are case insensitive on NSS.
- 10 After the pool appears in the list, continue in the *Storage* task by clicking *Volumes*.
- 11 Click *New*.
- 12 In the *Name* field, type `home_nss`, then click *Next*.

- 13 Click the box next to *POOL_LX*, then click *Next*.
- 14 Scroll down to *File Information > Lookup Namespace*
Long should be selected by default.
 This setting avoids having the NCP server spend cycles doing Long namespace lookups.
- 15 Click *Finish*.
HOME_NSS is listed as an available volume.
- 16 Continue with the next section, [Home Directories on NetWare 6.5](#).



3.7.2 Home Directories on NetWare 6.5

The default file system for NetWare 6.5 is NSS, which is an NCP volume by definition.

NetWare servers don't contain a HOME volume (partition) by default, but it is standard practice among NetWare administrators to create a HOME volume for their network users' private directories.

Creating a HOME_NW Volume on the NetWare 6.5 SP8 Server

Your NetWare virtual machine has approximately 16.5 GB of disk space still available for another NSS pool and volume on disk 0, which is the 25 GB file you created for the VM in [Section 2.3.3, "Creating a Virtual Machine and Installing NetWare,"](#) on page 35.

- 1 In iManager, click the *Roles and Tasks* icon .
 You can manage storage on the NetWare LAB_NW_VM server even though you are running iManager on your OES 2 getting-started lab server. This demonstrates one advantage of the tight integration of OES 2 services with eDirectory.
- 2 Click *Storage > Pools*.
- 3 Click the *Browse* icon  next to the *Server* field,
- 4 Browse to and select the LAB_NW server object (in *COMPANY > LAB > SERVERS*).
 Notice that a pool named *SYS* already exists. This pool contains the default volumes and files created with the NetWare server, including a volume that is also named *SYS*.
- 5 Click *New*.
- 6 Name the pool *pool_nw* and click *Next*.
- 7 Click the box next to the XenHD device in your virtual machine.
 This "device" is the 25 GB file that you created for the virtual machine. The file currently contains all the virtualized NetWare server's partitions and files.
- 8 By default, all of the free space on the disk should be automatically entered in the *Used Size* field, and the amount should match the *Free Size (MB)* displayed to the right of the system disk. If the *Used Size* field is blank, type in the free space amount.
- 9 Click *Finish*.
POOL_NW is listed as an available pool.
- 10 In the left frame, click *Volumes*.
- 11 Click *New*.
- 12 In the *Name* field, type *home_nw*, then click *Next*.

13 Click the box next to *POOL_NW*, then click *Next*.

14 Click *Finish*.

3.7.3 Summary of Getting-started Lab Home Directories and Purposes

Your getting-started lab servers now have four *home* directory access points in three physical locations (the first two share the same physical partition):

- ♦ **/home:** This is the default home directory on SLES 10 servers. The underlying file system is Reiser. On SLES 10 servers, home directories are normally created on */home* by users logging in to the server for the first time.

Home directories on OES 2 servers are normally created on NCP or NSS volumes. However, they can be created manually on */home*. User and Group ownership must be manually adjusted because the directories belong initially to the *root* user that creates them.

- ♦ **HOME_NCP:** This is an NCP volume mount point that points to and shares disk space with the */home* directory mentioned above. In this guide, it illustrates the functionality of the NCP server, the Novell File and Directory Trustee Model, and Novell Client™ access to a Linux POSIX volume. (The underlying file system is Reiser.) Home directories on NCP volumes are easily created when users are created in iManager. POSIX permissions to home directories created in iManager must be adjusted before users can access the directories through non-NCP applications. This is because when the directories are created, the directory owner in POSIX is initially the eDirectory Admin User who created the users in eDirectory and their home directories on the Linux file system (NCP volume).
- ♦ **HOME_NSS:** This is an NSS volume on the OES 2 server. It illustrates the functionality of the NCP server, the Novell File and Directory Trustee Model, and NSS file attributes. Because NSS volumes are also NCP volumes by default, home directories are easily created at user-creation time in iManager. POSIX permissions do not apply to NSS volumes. However, NSS can interface with POSIX permissions for applications and access methods that require them. Trustee assignments (ownership) are automatically assigned to the eDirectory username or user when the home directory is created.
- ♦ **HOME_NW:** This is an NSS volume on your virtualized NetWare server. It illustrates the functionality of the NCP server, the Novell File and Directory Trustee Model, and NSS file attributes on a NetWare server. Trustee assignments (ownership) are automatically assigned to the eDirectory user when the home directory is created.

3.8 Creating Users

For the getting-started lab exercises, you need to create the users shown in [Table 3-1](#).

IMPORTANT: There are seven users, each representing a different user type you might need on your network.

Although the user names are unusual, they let you track home directory locations and service access at a glance.

Each name includes “edir” to indicate that eDirectory users have access to the traditional Novell services highlighted in this guide:

- ♦ Novell AFP (Macintosh networking)
- ♦ Novell CIFS (Windows networking)



- ◆ Novell iFolder[®] 3.8
- ◆ NetStorage

The steps for creating users begin after [Table 3-1](#).

Table 3-1 *Users to Create*

Username	First Name	Last Name	Home Directory Volume	What This User Demonstrates
linux1_lum-edir	Linux1	Lum-edir	/home	<p>You manually create this user's home directory in the server's /home directory.</p> <p>If LUM is configured to allow login or sshd access, this user can access the OES 2 server as though it is a local user.</p>
linux2_lum-edir	Linux2	Lum-edir	/home	<p>You manually create this user's home directory in the server's /home directory.</p> <p>If LUM is configured to allow login or sshd access, this user can access the OES 2 server as though it is a local user.</p> <p>The difference between this user and the linux1 user is that its home directory is not adjusted for privacy but has the default POSIX permissions.</p>
ncp_edir	Ncp	Edir	<i>DNSname_HOME_NCP</i>	<p>This user's home directory is created by specifying the HOME_NCP volume at user-creation time in iManager.</p> <p>When the instructions in this section are complete, the user has access to only the traditional Novell services: AFP, CIFS, iFolder, and NetStorage.</p>
ncp_lum-edir	Ncp	Lum-edir	<i>DNSname_HOME_NCP</i>	<p>This user's home directory is created by specifying the HOME_NCP volume at user-creation time in iManager.</p> <p>When the instructions in this section are complete, the user has potential access to the server as a local user, in addition to traditional Novell service access.</p>

Username	First Name	Last Name	Home Directory Volume	What This User Demonstrates
nss_edir	Nss	Edir	<i>DNSname_HOME_NSS</i>	<p>This user's home directory is created by specifying the HOME_NSS volume at user-creation time in iManager.</p> <p>The user has access to only the traditional Novell services: AFP, CIFS, iFolder, and NetStorage.</p>
nss_lum-edir	Nss	Lum-edir	<i>DNSname_HOME_NSS</i>	<p>This user's home directory is created by specifying the HOME_NSS volume at user-creation time in iManager.</p> <p>In addition to traditional Novell services access, the user has access to the server as a local user.</p>
nw_edir	Nw	Edir	LAB_NW_HOME_NW	<p>This user represents the traditional NetWare user in eDirectory.</p> <p>This user's home directory is created by specifying the HOME_NW (NSS) volume at user-creation time in iManager.</p> <p>The user has access to only the traditional Novell services: AFP, CIFS, iFolder, and NetStorage. However, you could also LUM-enable the user (and the other non-LUM users as well) to verify that full OES 2 services are potentially available to all eDirectory users.</p>

- 1 In iManager, in the left pane, click *Users > Create User*.
- 2 In the *Username* field, type a username from [Table 3-1](#).
For the first user, this is linux1_lum-edir.
- 3 Type the first name and last name for the user as shown in [Table 3-1](#).
- 4 Click the *Browse* icon  next to the *Context* field.
- 5 For the first user, browse to the *USERS* object (*COMPANY > LAB > USERS*), then click the object.
For subsequent users, click the *Object History* icon  and select the *USERS* object's fully distinguished name (FDN).
- 6 Type the same password in both the *Password* and *Retype Password* fields.
- 7 Do not select *Set Simple Password*.
This is not required for OES because Universal Password is used.
- 8 If the Home Directory Volume cell in the table shows */home*, skip to [Step 9](#).

For the other users, select the *Create Home Directory* option and browse  to the NCP volume indicated. (Volumes are in the SERVERS OU.)

The home directories for the linux* users are created later.

- 9 Click *OK*.
- 10 Click *Repeat Task* to repeat the process until the other users listed in [Table 3-1 on page 52](#) are created.
- 11 Do not close iManager. Continue with the next section, [A Note about Identity Manager 3.6 Bundle Edition](#).

3.9 A Note about Identity Manager 3.6 Bundle Edition

If your organization has more than one directory service that stores user information, you should consider implementing the Novell Identity Manager 3.6 Bundle Edition included with Novell Open Enterprise Server.

The Identity Manager 3.6 Bundle Edition provides licensed synchronization of information (including passwords) held in NT Domains, Active Directory* Domains, and eDirectory trees.

Not only can you import User objects into eDirectory rather than creating them as you have in this section, but you can use Identity Manager to keep all the user data (including passwords that are stored in your different databases) synchronized.

When data from one system changes, Identity Manager detects and propagates these changes to other connected systems based on the business policies you define.

For more information, see “[Using the Identity Manager 3.6.1 Bundle Edition](#)” in the *OES 2 SP3: Planning and Implementation Guide*.

Continue with [Chapter 4, “eDirectory Linux Access \(LUM\),” on page 55](#).

4 eDirectory Linux Access (LUM)

Novell® Linux User Management (LUM) is a key component of Novell Open Enterprise Server (OES) and lets you require users who are accessing PAM-enabled services, such as FTP or SSH, on the OES 2 server to authenticate through eDirectory™.

This section discusses the following:

- Section 4.1, “Overview of Linux User Management,” on page 55
- Section 4.2, “Creating Group Objects,” on page 56
- Section 4.3, “Enabling the LUMUsers Group for Linux User Management (LUM),” on page 57
- Section 4.4, “Allowing SSH Access,” on page 58
- Section 4.5, “Creating a Home Directory for the linux* Users,” on page 59

4.1 Overview of Linux User Management

Figure 4-1 illustrates how LUM works with PAM-enabled services. For more detailed information, see “Linux User Management: Access to Linux for eDirectory Users” in the *OES 2 SP3: Planning and Implementation Guide*. As illustrated, OpenWBEM is the only PAM-enabled service that is active by default.

Figure 4-1 Linux User Management on OES

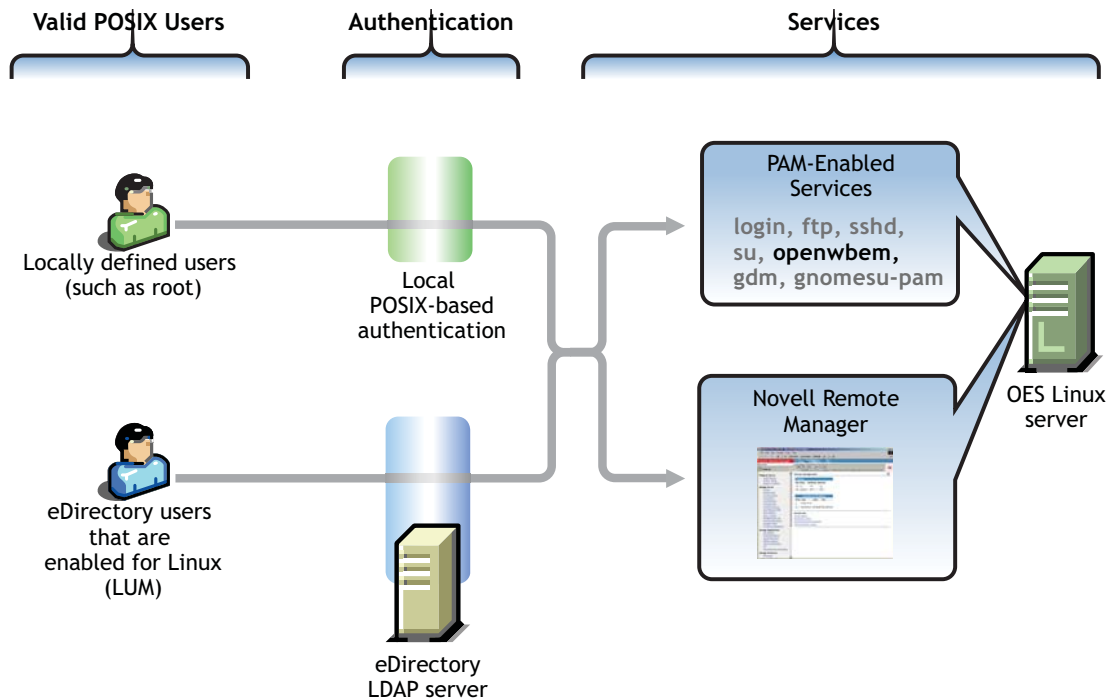

The user-creation steps you completed earlier in this guide ([Section 3.8, “Creating Users,” on page 51](#)) created three LUM users with limited rights as local users on the OES 2 server.

4.2 Creating Group Objects

To simplify user management, you should create one or more groups and associate users with those groups. Groups let you manage multiple users at the same time.

Some actions can only be performed at the group level. For example, enabling users for LUM requires making them members of a group that is enabled for LUM.

For the exercises in this guide, you will create two groups:



- ♦ **LUMUsers:** This group is used to LUM-enable some of the users you have created. Having the group lets us explore how LUM works and directly experience the SSH security precautions that are built into OES 2.
- ♦ **AllUsers:** This group is for all of the eDirectory user objects, including those that are LUM-enabled and those that have only traditional Novell services access.



IMPORTANT: Creating a group named users seems logical to many eDirectory administrators.

Unfortunately, all SLES 10 servers already have a system-created local group named users, and creating a duplicate group in eDirectory causes problems.

For more information, see “[Avoiding POSIX and eDirectory Duplications](#)” in the *OES 2 SP3: Planning and Implementation Guide*.

To create the required group objects:







- 1 In iManager > *Roles and Tasks*, click *Groups* > *Create Group*.
- 2 In the *Group Name* field, type LUMUsers.
The name contains uppercase and lowercase letters simply to illustrate that case is preserved in object names. Some administrators use mixed case to improve readability.
- 3 Click the *Browse*  icon next to the *Context* field.
- 4 Browse to the USERS container object.
- 5 Click *OK* > *Modify*.
- 6 Click the *Members* tab.
- 7 Click the *Browse* icon  next to the *Member* field.
- 8 Browse to the USERS container and click the down-arrow  next to it.
- 9 Select the following User objects:
 - ♦ linux1_lum-edir
 - ♦ linux2_lum-edir
 - ♦ ncp_lum-edir
 - ♦ nss_lum-edir
- 10 Click *OK* > *Apply* > *OK*.
- 11 Click *Create Group*.
- 12 In the *Group Name* field, type AllUsers.

- 13 Click the *Object History* icon  and select the USERS object's fully distinguished name (FDN).
- 14 Click *OK > Modify*.
- 15 Click the *Members* tab.
- 16 Click the *Browse* icon  next to the *Members* field.
- 17 Shift-click *linux1_lum-edir*, drag the mouse down to select all the users, then click *nw_edir*.
All of the users are added to the list.
- 18 Click *OK > Apply > OK*.
- 19 Do not close iManager. Continue with the next section, [Enabling the LUMUsers Group for Linux User Management \(LUM\)](#).

4.3 Enabling the LUMUsers Group for Linux User Management (LUM)

IMPORTANT: LUM-enabling users is an important part of these getting-started lab exercises. However, in a production environment you should avoid LUM-enabling users until you fully understand the potential security issues. For more information, see “[SSH Services on OES 2](#)” in the *OES 2 SP3: Planning and Implementation Guide*.

If you want eDirectory users to access PAM-enabled services such as login or sshd (SSH), on an OES 2 server, you must LUM-enable the users.

- 1 In the *Roles and Tasks* list, click *Linux User Management > Enable Groups for Linux*.
- 2 Click the *Browse* icon  next to the *Group Name* field.
- 3 Click *LUMUsers > OK*.
- 4 Make sure the *Linux-Enable All Users in These Groups* option is selected, then click *Next* twice.
- 5 Click the *Browse* icon  next to the *Unix Workstation Name* field.
- 6 Click the up-arrow .
- 7 Click the down-arrow  next to *SERVERS*.
- 8 Click the *UNIX Workstation* object for the OES 2 getting-started lab server, then click *OK*.
- 9 Click the *Browse* icon  next to the *Unix Config Object* field.
- 10 Click the up-arrow  twice.
- 11 Click the *UNIX Config* object.
- 12 Click *Next > Finish > OK*.

LUM-enabled access to OES 2 servers is enabled on an individual server basis. If you install additional OES 2 servers that require LUM access, they must also be added to a LUM-enabled group.

The LUMUsers group and its users are now recognized by the OES 2 server as local users.

- 13 Do not close iManager. Continue with the next section, [Allowing SSH Access](#).

4.4 Allowing SSH Access

To illustrate how LUM-enabled services work, we will briefly experiment with SSH access for eDirectory LUM-enabled users. In [Section 10.2.4, “SSH and NetStorage Administration,” on page 88](#), you will see that SSH access is required for a key NetStorage administration feature.

Complete the steps in the following sections:

- ♦ [Section 4.4.1, “Allowing SSH Access Through the Firewall,” on page 58](#)
- ♦ [Section 4.4.2, “Adding SSH as an Allowed Service in LUM,” on page 58](#)
- ♦ [Section 4.4.3, “Verifying SSH Access,” on page 58](#)

4.4.1 Allowing SSH Access Through the Firewall

- 1 On the OES 2 getting-started lab server, click *Computer > YaST Administrator Settings*, then click *Security and Users > Firewall*.
- 2 In the left navigation frame, click *Allowed Services*.
- 3 In the *Services to Allow* drop-down list, select *SSH*.
- 4 Click *Add > Next > Accept*.

The firewall is now configured to allow SSH connections with the server.

- 5 Continue with [Adding SSH as an Allowed Service in LUM](#).

4.4.2 Adding SSH as an Allowed Service in LUM

- 1 In YaST in the *Open Enterprise Server* group, click *OES Install and Configuration*.
- 2 Click *Accept*.
- 3 When the Novell Open Enterprise Server Configuration page has loaded, click the *Disabled* link under *Linux User Management*.

The option changes to *Enabled* and the configuration settings appear.

- 4 Click *Linux User Management*.
- 5 Type the eDirectory Admin password in the appropriate field, then click *OK > Next*.
- 6 In the list of allowed services, click *sshd*.
- 7 Click *Next > Next > Finish*, then close YaST.
- 8 Continue with [Verifying SSH Access](#).

4.4.3 Verifying SSH Access

The LUMUsers group in eDirectory now has SSH as an allowed service. To verify this:

- 1 On the getting-started lab workstation, in the iManager *Roles and Tasks* list, click *Directory Administration > Modify Object*.
- 2 Click the *Browse* icon  next to the *Object Name* field.
- 3 Browse to and select the *LUMUsers* group object (in *COMPANY > LAB > USERS*), then click *OK*.
- 4 Click the *Linux Profile* tab, click the *General* sub-tab, then select the *UNIX Workstation* object.
- 5 Click the *Linux Services* sub-tab.

- 6 Notice that `sshd` (the SSH daemon) is listed as a LUM-Enabled service, then click *OK*.
- 7 (Optional) If you want to verify that SSH access works, install an SSH client on the workstation and attach to the getting-started lab server through one of the LUM-enabled users. Be aware, however, that this creates a POSIX home directory for the user in `/home` and might require adjustments to procedures in the next section, [Creating a Home Directory for the linux* Users](#).
- 8 Continue with [Creating a Home Directory for the linux* Users](#).

4.5 Creating a Home Directory for the linux* Users

The NetStorage exercises in this guide involve users' home directories and specific files they will copy to those directories. However, neither of the linux* users currently has a home directory.

There are two standard ways to create home directories on Linux servers. The first way is for a user to log in to the server as a local user (or for OES 2, as a LUM-enabled user). For example, opening an SSH session creates a home directory.

Because it is unlikely that you want your users to have direct physical access to a production server, we will use the second way, which is to create the directory manually, assign the user and group to the directory, and then modify access permissions.

There are two methods you can use to do this.

- ♦ [Section 4.5.1, "Using the File Browser," on page 59](#)
- ♦ [Section 4.5.2, "Using Terminal Commands," on page 60](#)

4.5.1 Using the File Browser

To create home directories for your linux* users using the graphical interface, do the following:

- 1 As the root user, open a terminal prompt and enter the following command:

```
namconfig cache_refresh
```

This refreshes the LUM cache and is required for Linux-enabled users and groups to display in the GUI unless a few hours have elapsed since you created them. The default cache refresh rate in SP3 is 8 hours.

- 2 As the root user on the server's desktop, click *Computer > Home Folder*.
- 3 In the left panel, double-click *File System*, then double-click the home folder.
- 4 If you see home directories for only the `ncp_*` users that were created in iManager on the `HOME_NCP` volume, continue with [Step 5](#).

If you see a home directory for one of the linux* users, that means you used it to experiment with SSH access in [Step 7 on page 59](#), thus creating a home directory for the user. In that case, adjust the steps that follow as required.

- 5 Right-click the white space in the right panel and select *Create Folder*.
- 6 Type `linux1_lum-edir` as the folder name, then right-click the folder and select *Properties*.
- 7 Click the *Permissions* tab.
- 8 Click the *File Owner* drop-down list, then use the Up-arrow and Down-arrow keys to navigate to and select the `linux1_lum-edir` user.

Notice that the users that you created who are not enabled for LUM are not listed.

- 9 Click the *File Group* drop-down list, navigate to and select *LUMUsers*, then press Enter.

Neither this group nor the user you selected exist locally. However, because they are LUM-enabled, the server recognizes them as though they do.

The next three lines (Owner, Group, Others) indicate access permissions for the directory owner (linux1_lum-edir), the assigned group (LUMUsers), and everyone else (others).

Notice that both Group and Others have permission to *Read* (open) the contents of the folder and *Execute* (browse its contents). This is not what NetWare® administrators and users expect because home directories are private on NetWare servers.

- 10 Make this directory private by deselecting all of the access permissions for Group and Others.

For more information about directory privacy and aligning access on Linux servers to match what NetWare administrators are accustomed to, see “[Aligning NCP and POSIX File Access Rights](#)” in the *OES 2 SP3: Planning and Implementation Guide*.

- 11 Click *Close*.
- 12 Right-click the white space in the right panel and select *Create Folder*.
- 13 Type linux2_lum-edir as the folder name, then right-click the folder and select *Properties*.
- 14 Click the *Permissions* tab.
- 15 Change the file owner to linux2_lum-edir and the file group to LUMUsers by using the drop-down lists.
- 16 Adjust the permissions for this directory by enabling the Write right for the group. This gives full rights to the user’s home directory for anyone in the LUMUsers group, which is obviously not something you would normally do.

Later in the guide we will use this to contrast default POSIX file permissions with the Novell File and Directory Security Model.

- 17 Click *Close*.
- 18 Continue with [Novell CIFS on OES 2](#).

4.5.2 Using Terminal Commands

Creating home directories for the linux* users, assigning ownership of the directories, and granting access permissions involves three terminal commands:

- ♦ **mkdir:** Use this command to make POSIX directories.
- ♦ **chown:** Use this command to change user, group, and other ownership of a directory. For more information, see “[Managing Access Rights](#)” in the *OES 2 SP3: Planning and Implementation Guide*.
- ♦ **chmod:** Use this command to change access permissions. For more information, see “[Managing Access Rights](#)” in the *OES 2 SP3: Planning and Implementation Guide*

Do the following:

- 1 As the root user, open a terminal prompt by clicking *Computer > Gnome Terminal*.
- 2 Create a home directory for the linux1_lum-edir user by entering the following command:

```
mkdir /home/linux1_lum-edir
```
- 3 Assign the linux1_lum-edir user and the LUMUser group as the owners of the linux1_lum-edir directory.

```
chown -R linux1_lum-edir:LUMUsers /home/linux1_lum-edir
```

Neither this group nor the user you specified exist locally. However, because they are LUM-enabled, the server recognizes them as though they do.

By default, both the LUMUsers group and other users on the system have permission to *Read* (open) the contents of the folder and *Execute* (browse its contents). This is not what NetWare[®] administrators and users expect because home directories are private on NetWare servers.

- 4 Assign all access privileges to the user owner of the `linux1_lum-edir` directory, and no privileges to the group owner or to other users on the system.

```
chmod 700 /home/linux1_lum-edir
```

- 5 Now create a home directory for the `linux2_lum-edir` user.

```
mkdir /home/linux2_lum-edir
```

- 6 Assign the `linux2_lum-edir` user and the LUMUser group as the owners of the `linux2_lum-edir` directory.

```
chown -R linux2_lum-edir:LUMUsers /home/linux2_lum-edir
```

- 7 Adjust the permissions for this directory by enabling the Read, Write and Execute rights for the group. This gives full rights to the user's home directory for anyone in the LUMUsers group, which is obviously not something you would normally do.

```
chmod 775 /home/linux2_lum-edir
```

By default, the permissions are set to 755. This command adds the Write right for the group. For more information, see "[Aligning NCP and POSIX File Access Rights](#)" in the *OES 2 SP3: Planning and Implementation Guide*.

Later in the guide we will use this to contrast default POSIX file permissions with the Novell File and Directory Security Model.

5 Novell CIFS on OES 2

Novell® CIFS lets Windows users access NSS volumes on Novell Open Enterprise Server 2 servers exactly as they would access a Windows file server. For a comparison to Novell Samba, see [“Comparing Your CIFS File Service Options”](#) in the *OES 2 SP3: Planning and Implementation Guide*.

This section discusses the following:

- ♦ [Section 5.1, “Overview of Novell CIFS,”](#) on page 63
- ♦ [Section 5.2, “Setting the Search Context,”](#) on page 64
- ♦ [Section 5.3, “Making Novell CIFS Shares Available to CIFS Users,”](#) on page 65
- ♦ [Section 5.4, “Novell CIFS Users Access Rights,”](#) on page 65

5.1 Overview of Novell CIFS

[Figure 5-1](#) illustrates the file services available through Novell CIFS in OES 2.

More Information on Novell CIFS file services in OES 2 is found in [“Novell CIFS Implementation and Maintenance”](#) in the *OES 2 SP3: Planning and Implementation Guide*.

Figure 5-1 Novell CIFS

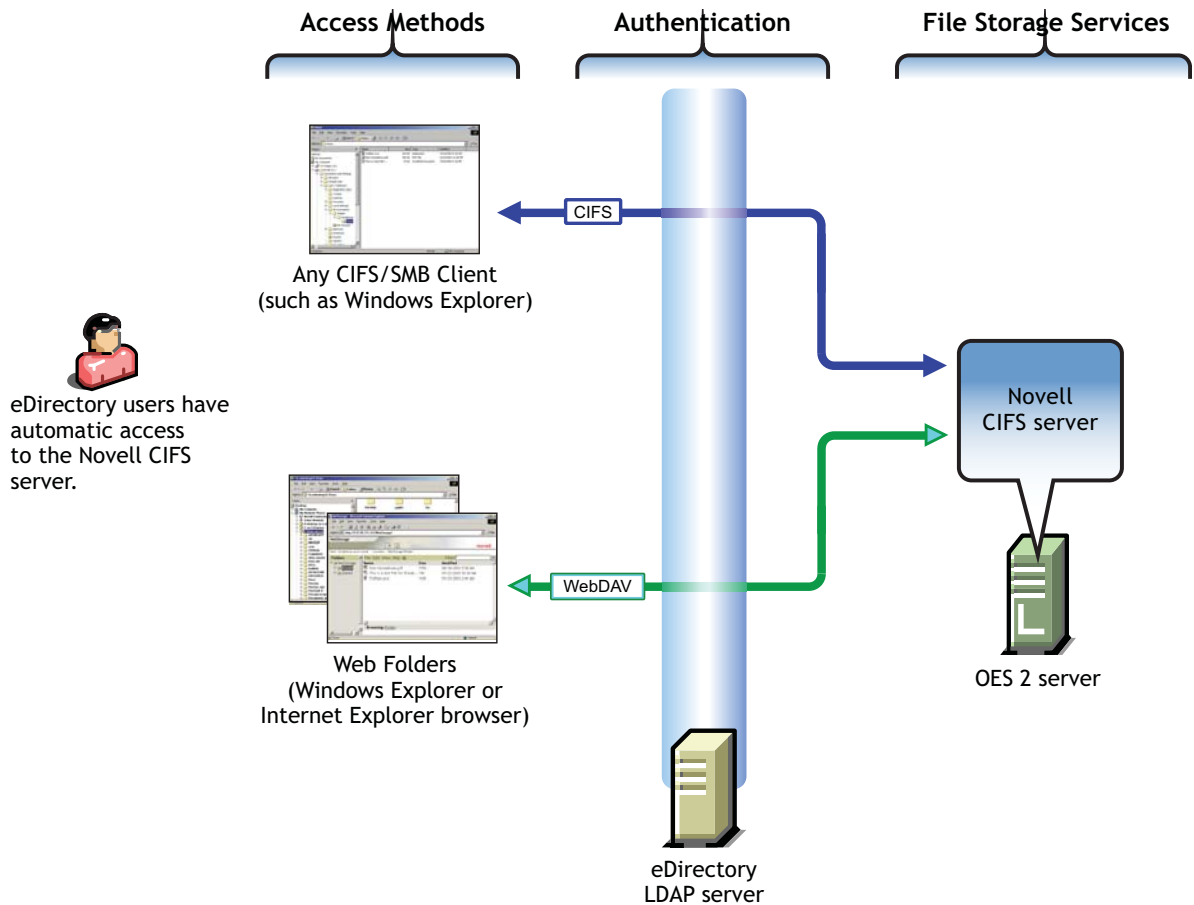

IMPORTANT: If you plan to use Novell CIFS in conjunction with Novell AFP and/or NCP file services, be sure to read "[Cross-Protocol File Locking Change](#)" in the *OES 2 SP3: Planning and Implementation Guide*.

5.2 Setting the Search Context

By default, the search context for CIFS users is set to the container where the OES 2 server is installed. The assigned proxy user searches in this context for users seeking access to the CIFS file service. You must set a context that points to the USERS container where your User objects are located.

- 1 In iManager > *Roles and Tasks*, click *File Protocols* > *CIFS*.
- 2 Click the *Browse* icon next to the *Server* field, then browse to and select the OES 2 getting-started lab server.
- 3 Click the *Context* tab.
- 4 Select the entry that points to the *SERVERS* container, then click *Remove*.
In the tree you created, there are no users in the *SERVERS* container.
- 5 Click *Add*.
- 6 Browse to and select the *USERS* container, then click *OK*.
- 7 Continue with [Making Novell CIFS Shares Available to CIFS Users](#).

5.3 Making Novell CIFS Shares Available to CIFS Users

By default, all NSS volumes hosted on an OES 2 server have shares associated with them. If you need a share to point to a subdirectory on an NSS volume, then you must create a new share. See “[Adding a New CIFS Share](#)” in the *OES 2 SP3: Novell CIFS for Linux Administration Guide*.

If a volume is created while the Novell CIFS service is running, the service must be restarted to discover the volume.

- 1 Click the *Shares* tab.
- 2 If the *HOME_NSS* share is listed, skip to [Novell CIFS Users Access Rights](#).
If not, continue with [Step 3](#).
- 3 Click the *General* tab, then click *Stop*. The service status changes to *Stopped*.
- 4 Click the *Start* sub-tab. The service status changes to *Running*.
- 5 Click the *Shares* tab.
The *HOME_NSS* share is listed.

5.4 Novell CIFS Users Access Rights

As illustrated in [Figure 5-1](#), all eDirectory users have automatic access to the Novell CIFS file service, assuming that the service is configured correctly.

However, access to the CIFS file service does not equate to access to the NSS file system and the folders and files it contains. The Novell File and Directory Trustee Rights model ensures that users can see only those files and folders to which they have access rights.

6 Novell AFP

Novell® AFP lets Macintosh users access NSS volumes on Novell Open Enterprise Server 2 servers using AFP networking, exactly as they would Macintosh file servers.

This section discusses the following:

- ♦ [Section 6.1, “Overview,” on page 67](#)
- ♦ [Section 6.2, “Setting the Search Context,” on page 68](#)
- ♦ [Section 6.3, “Making NSS Volumes Available to AFP Users,” on page 68](#)
- ♦ [Section 6.4, “Novell AFP Users Access Rights,” on page 68](#)

6.1 Overview

[Figure 6-1](#) illustrates the file services available through Novell AFP in OES 2.

More Information on Novell AFP file services in OES 2 is found in “[Novell AFP Implementation and Maintenance](#)” in the *OES 2 SP3: Planning and Implementation Guide*.

Figure 6-1 AFP File Access Support on OES 2

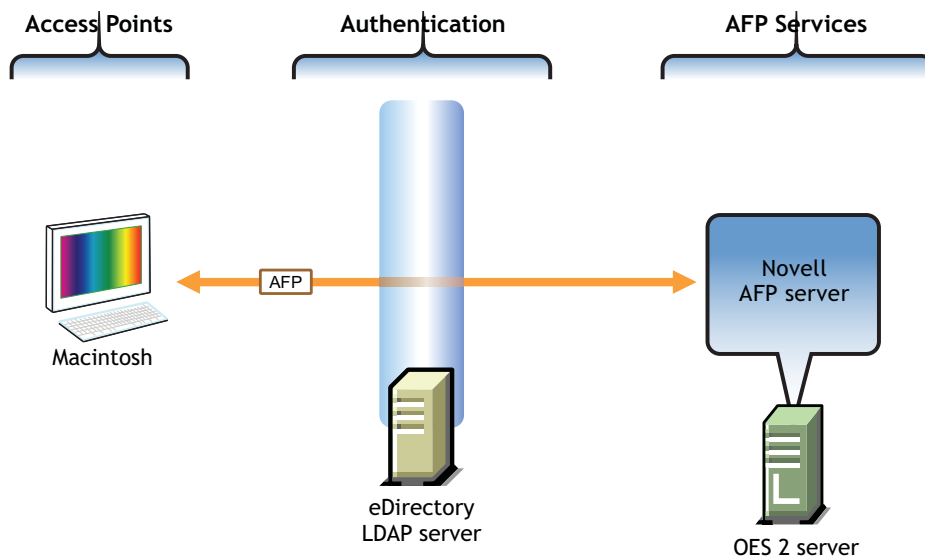

The exercises in this guide have you access the OES 2 server by using native Macintosh functionality.



IMPORTANT: If you plan to use Novell AFP in conjunction with Novell CIFS and/or NCP file services, be sure to read “[Cross-Protocol File Locking Change](#)” in the *OES 2 SP3: Planning and Implementation Guide*.

6.2 Setting the Search Context

By default, the search context for AFP users is set to the container where the OES 2 server is installed. AFP searches in this context for users seeking access to the AFP file service. You must set a context that points to the USERS container where your User objects are located.

- 1 In iManager > *Roles and Tasks*, click *File Protocols* > *AFP*.
- 2 Click the *Browse* icon next to the *Server* field, then browse to and select the OES 2 getting-started lab server.
- 3 Click the *Contexts* tab.
- 4 Select the entry that points to the *SERVERS* container and click *Remove*.
- 5 Click *Add*.
- 6 Browse to and select the *USERS* container, then click *OK*.
- 7 Continue with [Making NSS Volumes Available to AFP Users](#).

6.3 Making NSS Volumes Available to AFP Users

- 1 Click the *Volume* tab, then click *Add*.
- 2 Click the *Browse* icon  next to the *Volume* field.
- 3 In the Object Selector, click the down-arrow  next to the *servername_HOME_NSS* volume, then click the link to the volume.
- 4 In the *Shared Volume Name* field, type *AFP_Home_NSS* and click *OK*.

6.4 Novell AFP Users Access Rights

As illustrated in [Figure 6-1](#), eDirectory users can access any NSS volume where they are granted Novell trustee rights. For example, if they have a system-created home directory on the HOME_NSS volume, they can see that directory.

However, if they don't have Novell trustee rights, they cannot access the volume. This is different than for CIFS users.

As with CIFS users, the Novell File and Directory Trustee Rights model ensures that users can see only those files and folders to which they have access rights.

7 NetWare CIFS and AFP on OES 2

NetWare® 6.5 SP8 supports native file access methods from Linux, Macintosh, UNIX*, and Windows workstations to NSS volumes on NetWare servers. (Access to NetWare Traditional File System volumes is not supported.)

This section discusses the following:

- ♦ Section 7.1, “Overview,” on page 69
- ♦ Section 7.2, “Enabling NFAP Services on the LAB_NW Server,” on page 70

7.1 Overview

Figure 5-1 illustrates the native File Access Protocol (NFAP) support services that are enabled by installing NetWare 6.5. A more detailed overview of NFAP file services on OES is found in “Native File Access Protocols” in the *NW 6.5 SP8: Planning and Implementation Guide*.

Figure 7-1 Native File Access Support on NetWare 6.5

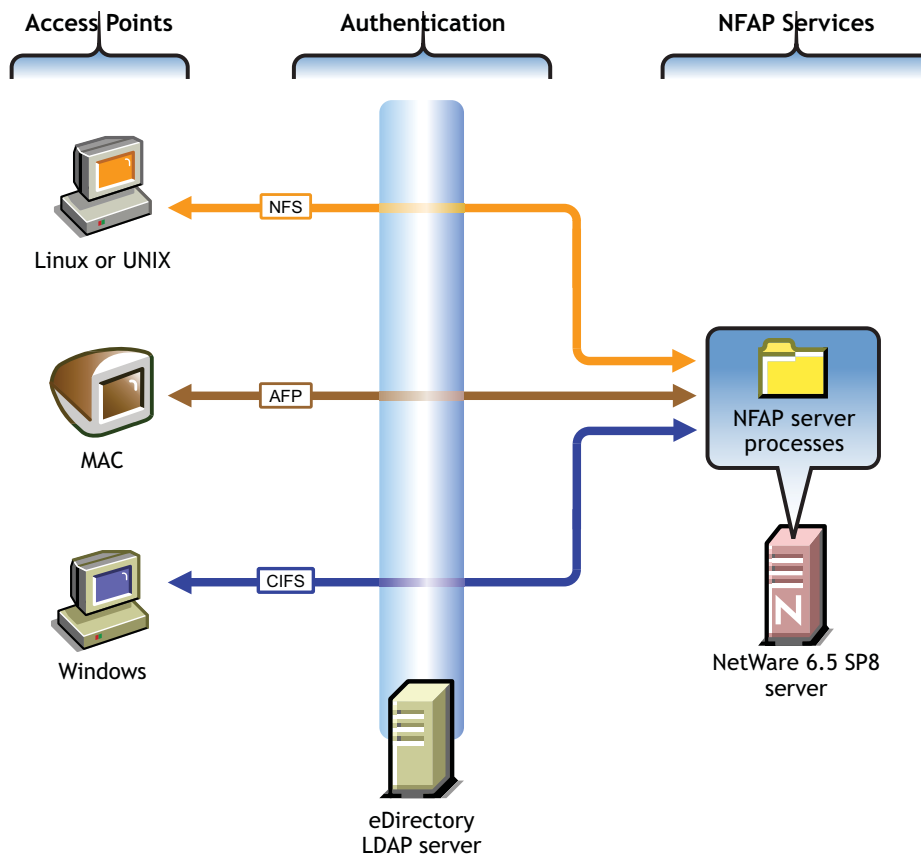

The exercises in this guide have you access the NetWare server by using native Windows functionality.

If you want to also experiment with Linux, UNIX, or Macintosh workstations, refer to the information in “[Native File Access Protocols Implementation and Maintenance](#)” in the *NW 6.5 SP8: Planning and Implementation Guide* after completing all the sections in this guide.

7.2 Enabling NFAP Services on the LAB_NW Server



When you created the `nw_edir` user in iManager, you also created a home directory for the user on the `HOME_NW` NSS volume on the virtualized NetWare server `LAB_NW`.

By default, all NSS volumes on NetWare servers are available for CIFS and AFP access. To configure CIFS access, you must complete two tasks:

- ♦ [Section 7.2.1, “Creating a Share for the HOME_NW Volume,” on page 70](#)
- ♦ [Section 7.2.2, “Specifying a Search Context,” on page 70](#)

7.2.1 Creating a Share for the HOME_NW Volume

NetWare CIFS requires that you specify the shares that users can access.

- 1 In iManager > *Roles and Tasks*, click *File Protocols* > *CIFS*.
- 2 Click the *Browse* icon next to the *Server* field, then browse to and select the `LAB_NW` server.
- 3 Click the *Shares* tab, then click the *Add* sub-tab.
- 4 In the *Share Name* field, type `home_nw`.
This is the name used to attach to the share.
- 5 Click the *Browse* icon  next to the *Volume* field.
- 6 In the Object Selector, click the down-arrow  next to the `LAB_NW_HOME_NW` volume, then click the link to the volume.
- 7 Click *OK* > *OK*.

7.2.2 Specifying a Search Context

You must specify a search context that NetWare can use to find users needing CIFS access.

- 1 Log into your VM host server as `root` and click *Computer* > *YaST* > *Virtualization* > *Virtual Machine Manager*.
- 2 Double-click the `LAB_NW_VM` virtual machine.
- 3 On the NetWare GUI, click the File Browser (folder) icon once to activate the mouse pointer and once to select the browser.
- 4 Double-click the `sys:` volume.
- 5 Double-click the `etc` folder.
- 6 Scroll down and double-click the `cifsctxs.cfg` file.
Notice that the search context is set to the `SERVERS` container. User searches occur only in the contexts specified in this file. Subcontainers are not searched.
- 7 Edit the file, replacing `SERVERS` with `USERS`, so that the line reads

OU=USERS.OU=LAB.O=COMPANY

- 8** Save the file, close the editor, and close the file browser.
- 9** Click the *Server Console* (computer) icon.
- 10** Stop and then start the CIFS service by entering the following commands:
CIFSSTOP
CIFSSTART
- 11** Press Ctrl+Alt to release the mouse, then close both of the Virtual Machine Manager windows.
- 12** Continue with [Chapter 8, "iFolder 3.8,"](#) on page 73.

8 iFolder 3.8

As a key file service component of Novell® Open Enterprise Server (OES), Novell iFolder® 3.8 provides a repository on one or more OES 2 servers that stores master copies of locally accessible files.

This section discusses the following:

- ♦ [Section 8.1, “Overview of iFolder,” on page 73](#)
- ♦ [Section 8.2, “Installing the iFolder Client,” on page 74](#)
- ♦ [Section 8.3, “Creating Corresponding Windows Users,” on page 75](#)
- ♦ [Section 8.4, “Refreshing the List of iFolder Users,” on page 75](#)
- ♦ [Section 8.5, “Configuring iFolder Accounts and Creating iFolders,” on page 76](#)

8.1 Overview of iFolder

[Figure 8-1](#) illustrates the file services that are enabled by completing the steps in the sections that follow.

More detailed information on iFolder file services on OES 2 is found in [“Novell iFolder 3.8”](#) in the *OES 2 SP3: Planning and Implementation Guide*.

Figure 8-1 iFolder File Services on OES

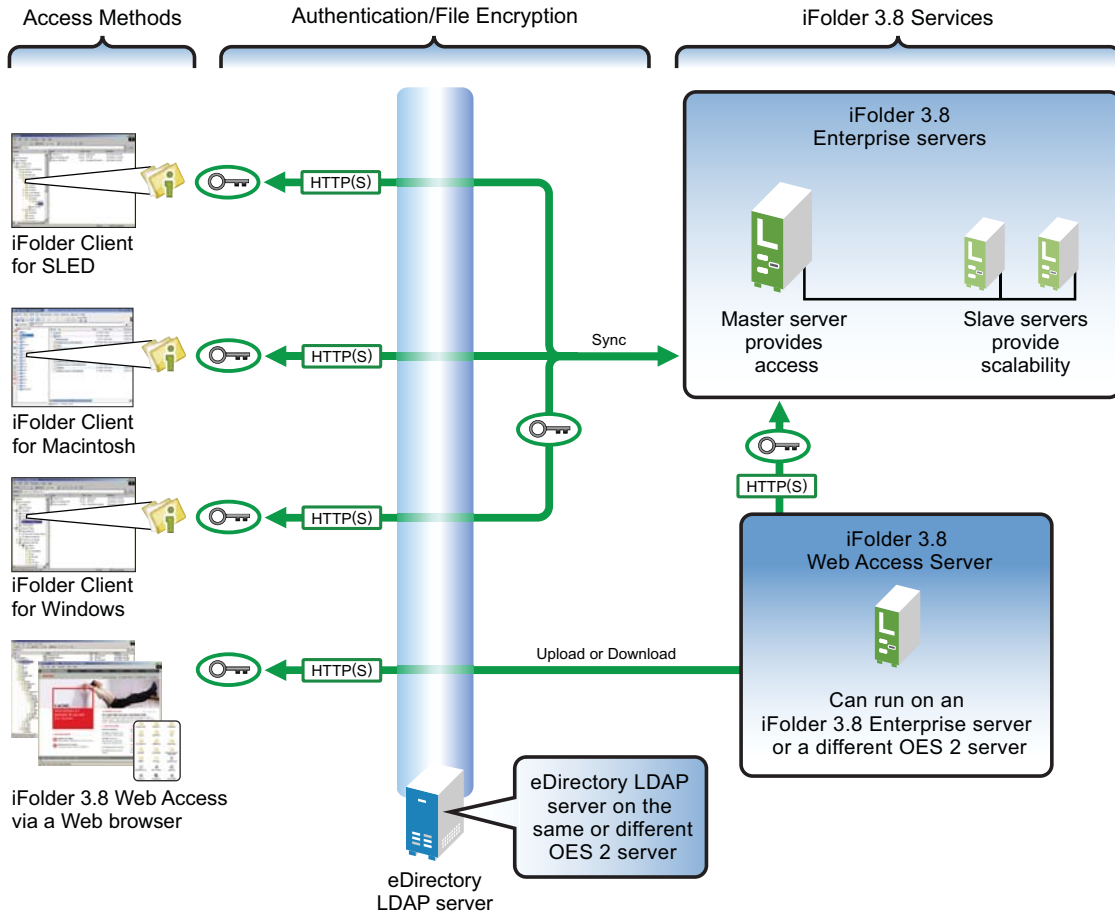

8.2 Installing the iFolder Client

NOTE: Although the exercises in this guide focus on Windows, the iFolder client is also available for Linux and Macintosh. For more information, see “Getting Started” the [Novell iFolder 3.8.4 Cross-Platform User Guide](#).

The iFolder client is required for two tasks:

- ♦ Automatically synchronizing local iFolder files with the files on the iFolder 3.8 enterprise server.
- ♦ Sharing iFolders with other users.

IMPORTANT: To install the client, the workstation must have an active Internet connection.

To install the iFolder client:

- 1 Log in to the workstation as a Windows administrative user.
- 2 In your browser, access your OES 2 server’s welcome pages by entering the following URL:

`http://IP_or_DNS`

where *IP_or_DNS* is the IP address of full DNS name of your getting-started lab server.

For example: `myserver.company.example.com`

- 3 On the OES 2 Welcome Page in the left panel, click the *Client Software* link.
- 4 Under *Available Downloads*, click the iFolder Client for Windows link appropriate for your workstation (32-bit or 64-bit).
- 5 Save the file.
- 6 Open the downloaded file and install the client.
The installation process includes several steps. For the installation to succeed, you must agree, accept, and answer Yes to the various prompts, including the unknown publisher alert and the Microsoft .NET installation if prompted. Accept all the defaults.
- 7 If you install Microsoft .NET, you might be prompted to restart the workstation. If prompted, click the *Restart* button, then after the workstation restarts, log in as the Windows administrative user.
- 8 Click through the dialog boxes, accepting the defaults until the process is finished. Then click *Finish > Yes* to restart the workstation.
- 9 After the workstation restarts, log in as an administrative user.
- 10 If needed, cancel the iFolder Account Creation Wizard by right-clicking the iFolder icon in the system tray and selecting *Exit*, then continue with [Creating Corresponding Windows Users](#).

8.3 Creating Corresponding Windows Users

Some OES services, such as Novell iFolder, interact seamlessly with Windows users that have the same username and password as the eDirectory™ users.

For the exercises in this guide, you must now create Windows user accounts for the users listed in [Table 3-1 on page 52](#) and assign each user the same password you specified for the corresponding eDirectory account.

- 1 On the Windows workstation, log in as an Administrator user.
- 2 Access the Control Panel and select *User Accounts and Family Safety > Add or Remove User Accounts* (Windows 7) or *User Accounts* (Windows XP).
- 3 Create a user account for each user in [Table 3-1 on page 52](#), specifying that the account is a computer administrator.
- 4 Select the user after creating it, and then create the same password for the user that you specified in [Step 6 on page 53](#).
- 5 Repeat from [Step 3](#) for each additional user, then continue with [Refreshing the List of iFolder Users](#).

8.4 Refreshing the List of iFolder Users

All eDirectory users are enabled for access to iFolder 3.8 by default. However, the iFolder 3.8 Administration utility must be synchronized with eDirectory. By default this happens every 24 hours.

- 1 Open your browser and log in to iManager as admin.
If you receive a Tomcat error, see [Section A.2, “iManager Tomcat Error,” on page 111](#).
- 2 In Roles and Tasks, click *iFolder 3.8 > Launch iFolder Admin Console*.
- 3 In the *iFolder Server* field, type the IP address of the OES 2 getting-started lab server.
- 4 Select the *Authenticate Using Current iManager Credentials* option.

5 Click *OK*.

The *Users* tab shows the users that are recognized by the iFolder server as having iFolder service access. Because the LDAP search context doesn't include the *USERS* container, the eDirectory users you have added don't appear in the list.

6 Click the *Servers* tab.

7 Click the blue link for the OES 2 getting-started lab server.

8 In the *LDAP Details* section, click the *Edit* button.

9 In the *LDAP Admin DN* field, type `cn=admin,o=company`.

Notice that the delimiter is a comma (`,`), not a period (`.`).

10 In the *LDAP Admin Password* field, type the Admin user password.

11 In the *LDAP Contexts* field, change *SERVERS* to *USERS*, then click *OK*.

This changes the search context to the *USERS* directory.

12 In the *LDAP Details* section, click the blue *Sync Now* link.

Notice that the default synchronization interval is 1440 minutes (24 hours).

13 Click the *Users* tab.

Notice that the users you have created are added to the list.

14 Close the iFolder Administration console, then continue with [Configuring iFolder Accounts and Creating iFolders](#).

8.5 Configuring iFolder Accounts and Creating iFolders

Before users can create iFolders, they must set up an iFolder account on the workstation.

You should have already created a Windows user account for each eDirectory user as instructed in [Section 8.3, "Creating Corresponding Windows Users," on page 75](#). You will now configure an iFolder for `linux1_lum-edir` and invite the `ncp_edir` and `nw_edir` users to share the iFolder. Although you can create accounts for the other users, there are no exercises in this guide that involve them having iFolder accounts.

1 Log off as the administrative user, then log in to the Windows workstation as the `linux1_lum-edir` user that you created in [Section 8.3, "Creating Corresponding Windows Users," on page 75](#).

2 After the login process finishes, you should be prompted to set up an iFolder account. Click *Next*.

If you are not prompted to set up an account, right-click the iFolder icon on the toolbar, select *Accounts*, then click *New*.

3 In the *Server Address* field, type the IP address or DNS hostname of your OES 2 server, then click *Next*.

4 Type the `linux1_lum-edir` for the username, then type the password you assigned to the user.

5 Select *Remember Password*, then click *Next > Connect*.

6 If prompted, accept the certificate by clicking *Yes*.

7 When prompted to create a default iFolder, deselect *Create Default Folder*, click *Next*, click *Finish*, and then close the iFolder information window.

8 Right-click the desktop, then click *New* and create a new folder named `linux1_lum-edir_IF3`.

9 After creating the folder, right-click it, then click *Convert to an iFolder*.

- 10 Click *OK*.
- 11 In the message that points out how iFolder folder icons look different, select *Do Not Show This Message Again*, then click *Close*.
- 12 Right-click the iFolder, then select *iFolder > Share with*.
- 13 In the iFolder Properties dialog box, click *Add*.
- 14 In the *iFolder Users* column, click *Ncp Edir*, then click *Add>>*.
Ncp Edir is added to the *Selected Users* column.
- 15 Add *Nzw Edir* to the *Selected Users* column as well.
- 16 Click *OK*.
- 17 Change the access rights for *Ncp Edir* from *Read Only* to *Read/Write* by doing the following:
 - 17a Click *Ncp Edir*.
 - 17b Click *Rights*.
 - 17c Select *Read/Write*.
 - 17d Click *OK*.
- 18 Click *Apply > OK*.
The two users are configured to access linux1_lum-edir's iFolder.
- 19 Log off the workstation.
- 20 Continue with [Chapter 9, "iPrint,"](#) on page 79.

9 iPrint

As the print services component of Novell® Open Enterprise Server (OES), Novell iPrint provides a powerful and easy-to-implement printing solution that lets your network users print from any Linux, Macintosh, or Windows workstation to any network printer.

This section discusses the following:

- ♦ [Section 9.1, “Overview of iPrint,” on page 79](#)
- ♦ [Section 9.2, “Creating an eDirectory Context for Printers,” on page 80](#)
- ♦ [Section 9.3, “Creating a Print Driver Store,” on page 81](#)
- ♦ [Section 9.4, “Creating a Print Manager Object,” on page 81](#)
- ♦ [Section 9.5, “Adding Printer Drivers to the Driver Store from the Windows Platforms,” on page 82](#)
- ♦ [Section 9.6, “Creating iPrint Printer Objects,” on page 83](#)

9.1 Overview of iPrint

[Figure 9-1](#) illustrates the printing services that are enabled by completing the steps in the sections that follow.

More detailed information on iPrint services in OES 2 is found in “[iPrint Functionality](#)” in the *OES 2 SP3: Planning and Implementation Guide*.

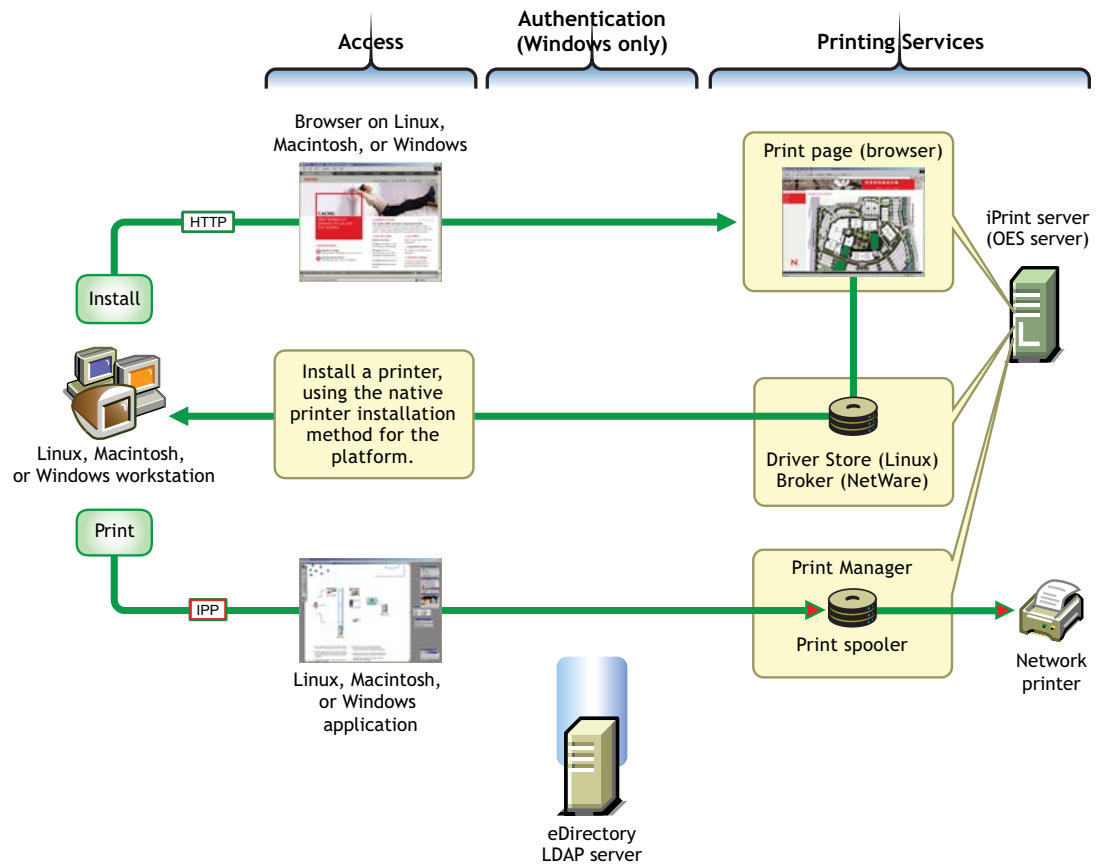

Figure 9-1 iPrint on OES



9.2 Creating an eDirectory Context for Printers







System administrators often create one or more container objects just for network printers. Obviously, this is an optional organizational preference issue. The printers themselves can be placed in the most convenient and accessible locations for your network users.

- 1 Log in to the getting-started lab Windows workstation as a Windows user with Administrator privileges.
- 2 If it appears, cancel the iFolder wizard.
- 3 Start iManager and log in as the Admin user.
If you receive a Tomcat error, see [Section A.2, "iManager Tomcat Error,"](#) on page 111.

- 4 Click the *View Objects* icon .
- 5 Click the *Browse* tab.
- 6 In the left pane, click the down-arrow  next to the COMPANY Organization object.
- 7 Click *LAB*, then select *Create Object* from the drop-down list.
- 8 From the *Available Object Classes* list, select *Organizational Unit*, then click *OK*.
- 9 In the *Organizational Unit Name* field, type *PRINTERS*.
- 10 Click *OK* twice.









9.3 Creating a Print Driver Store

iPrint stores print driver files by workstation type for each of your network printers in a driver store in eDirectory™.

- 1 In iManager, click the *Roles and Tasks* icon .
- 2 Click *iPrint > Create Driver Store*.
- 3 In the *Driver Store Name* field, type `Print_Drivers`.
- 4 Click the *Browse* icon  next to the *Container Name* field.
- 5 Click the down-arrow  next to LAB, then click the PRINTERS Organizational Unit object.
- 6 In the *Target Server* field, type the DNS name or the IP address of the server that will host the driver store.
- 7 Click the *Browse* icon  next to the *eDir Server name* field.
- 8 Click the down-arrow  next to LAB, click the down-arrow  next to SERVERS, then click your OES 2 getting-started lab server.
- 9 Click OK twice.
- 10 Continue with [Section 9.4, “Creating a Print Manager Object,”](#) on page 81.

9.4 Creating a Print Manager Object

The iPrint Manager is represented by and managed through a Print Manager object in eDirectory. It is a daemon that runs on the OES 2 server, and it must be running when you create Print objects. After printing is set up, the iPrint Manager receives print job requests and forwards them to printers when the printers are ready.

- 1 Continuing from [Step 9](#) in the previous section, click *iPrint > Create Print Manager*.
- 2 In the *Manager Name* field, type the following:
`iPrint_Manager`
- 3 Click the *Browse* icon  next to the *Container Name* field.
- 4 Click the down-arrow  next to LAB, then click PRINTERS.
- 5 Click the *Browse* icon  next to the *eDir Server name* field.
- 6 Click the down-arrow  next to LAB, click the down-arrow  next to SERVERS, then click your OES 2 getting-started lab server.
- 7 Click the *Browse* icon  next to the *Driver Store name* field.
- 8 Click the down-arrow  next to LAB, click the down-arrow  next to PRINTERS, then click *Print_Drivers*.
- 9 In one of the *iPrint Service* fields, type either the full DNS name of your getting-started lab server or its IP address, depending on the option you select.
- 10 Click OK twice.

9.5 Adding Printer Drivers to the Driver Store from the Windows Platforms

You can load printer drivers to the Driver Store by using driver files. However, because most Windows workstations have an extensive list of printer drivers available on the system, the simplest way to add drivers for a Windows workstation is to upload them directly.

You can upload Windows 7 drivers from a Windows 7 workstation and Windows XP drivers from a Windows XP workstation, etc.

Complete the following steps once for each of the Windows platforms (7, XP, etc.) that you have in your getting-started lab:

IMPORTANT: This procedure requires Internet Explorer 6 or later.

- 1 Open Internet Explorer 6 or later on the workstation and enter the following URL in the Address field:

`http://IP_or_DNS/ipp`

where *IP_or_DNS* is the IP address or DNS name of your OES 2 server.

- 2 Click the iPrint client link.
- 3 Click *Run* (or the corresponding option for your platform).
- 4 Answer yes to any security warnings, then click *Next* and follow any prompts.
- 5 After the client installs, click *Finish*.
- 6 Close the browser, then open it again.
- 7 Start iManager (`http://server/nps`) and log in as the Admin user.
If you receive a Tomcat error, see [Section A.2, “iManager Tomcat Error,”](#) on page 111.
- 8 If you are running Internet Explorer 6, skip to [Step 12](#).
or
For Internet Explorer 7 or later, you must configure the pop-up blocker. Continue with [Step 9](#).
- 9 Right-click above the iManager panel and make sure the *Menu Bar* option is selected.
- 10 In the Menu Bar, click *Tools > Pop-Up Blocker > Pop-Up Blocker Settings*.
- 11 In the *Address of Website to Allow* field, type the IP address of the OES 2 getting-started lab server, then click *Add > Close*.
- 12 Click *iPrint > Manage Driver Store*.
- 13 Click the *Browse* icon  next to the *iPrint Driver Store Name* field.
- 14 Browse to the Printers container (*COMPANY > LAB > PRINTERS*), then click the *Print_Drivers* object.
- 15 Click *OK*.
- 16 Click the *Drivers* tab.
- 17 If you are running Internet Explorer 6, skip to [Step 21](#).
or
If you are running Internet Explorer 7 or later and have not previously approved the iPrint ActiveX* plug-in to run, an Information Bar might appear directly above the iManager pane.







- 18 If no Information Bar appears directly above the iManager pane, skip to [Step 21](#).
- 19 Click the Information Bar and select *Run ActiveX Control*, then click *Run > Retry*.
- 20 Repeat from [Step 12](#).
- 21 In the *Drivers Platform* drop-down list, select the workstation type you are running.
You can add drivers from the system only for the workstation type you are running.
- 22 Click *Add from System*.

TIP: Although not practical for the step-by-step guided approach used in this guide, the *Add from File* is a more useful option for most administrators because it lets them install print drivers for multiple platforms from a single workstation. For more information see, “[Adding Printer Drivers](#)” in the *OES 2 SP3: iPrint for Linux Administration Guide*.

- 23 In the Add Resource dialog box, select the correct driver for the printer you plan to use for the getting-started lab test.
- 24 Click *OK*.
- 25 (Optional) To test multiple printers, repeat [Step 22](#) through [Step 24](#) for each printer you want to test.
- 26 When you are finished, click *Apply > OK*.

9.6 Creating iPrint Printer Objects

You can create iPrint Printer objects for all your printers that have drivers in the Driver Store and an IP address or DNS name.

- 1 In iManager, click the *Roles and Tasks* icon .
- 2 Click *iPrint > Create Printer*.
- 3 In the *Printer Name* field, type a name for your printer.
- 4 Click the *Browse* icon  next to the *Container Name* field.
- 5 Click the down-arrow  next to LAB, then click PRINTERS.
- 6 Click the *Browse* icon  next to the *Print Manager Name* field.
- 7 Click the down-arrow  next to LAB, click the down-arrow  next to PRINTERS, then click *iPrint_Manager*.
- 8 Type the DNS name or IP address of the printer in the field indicated.
- 9 Type a location so users know where to find the printer.
- 10 (Optional) Type a description.
- 11 Click *Next*.
- 12 Select the printer driver by using the drop-down list for the Windows platform of your getting-started lab workstation.
- 13 Click *Next*.
- 14 Select the default driver for your workstation type, then click *Next*.
- 15 Click *OK*.
- 16 Close iManager.
- 17 Continue with [Chapter 10, “NetStorage,”](#) on page 85.

10 NetStorage

As a versatile file services component of Novell® Open Enterprise Server (OES), NetStorage provides Web-based access to and management of any files on OES 2 servers, except the iFolder 3 files, which are accessed through the iFolder Web Access Server instead.

This section discusses the following:

- ♦ [Section 10.1, “Overview of NetStorage,” on page 85](#)
- ♦ [Section 10.2, “Making Directories Accessible Through NetStorage,” on page 86](#)

10.1 Overview of NetStorage

[Figure 10-1 on page 86](#) illustrates the NetStorage file services that are enabled by default.

More detailed information on NetStorage file services on OES is found in “[NetStorage](#)” in the *OES 2 SP3: Planning and Implementation Guide*.

Figure 10-1 NetStorage on OES

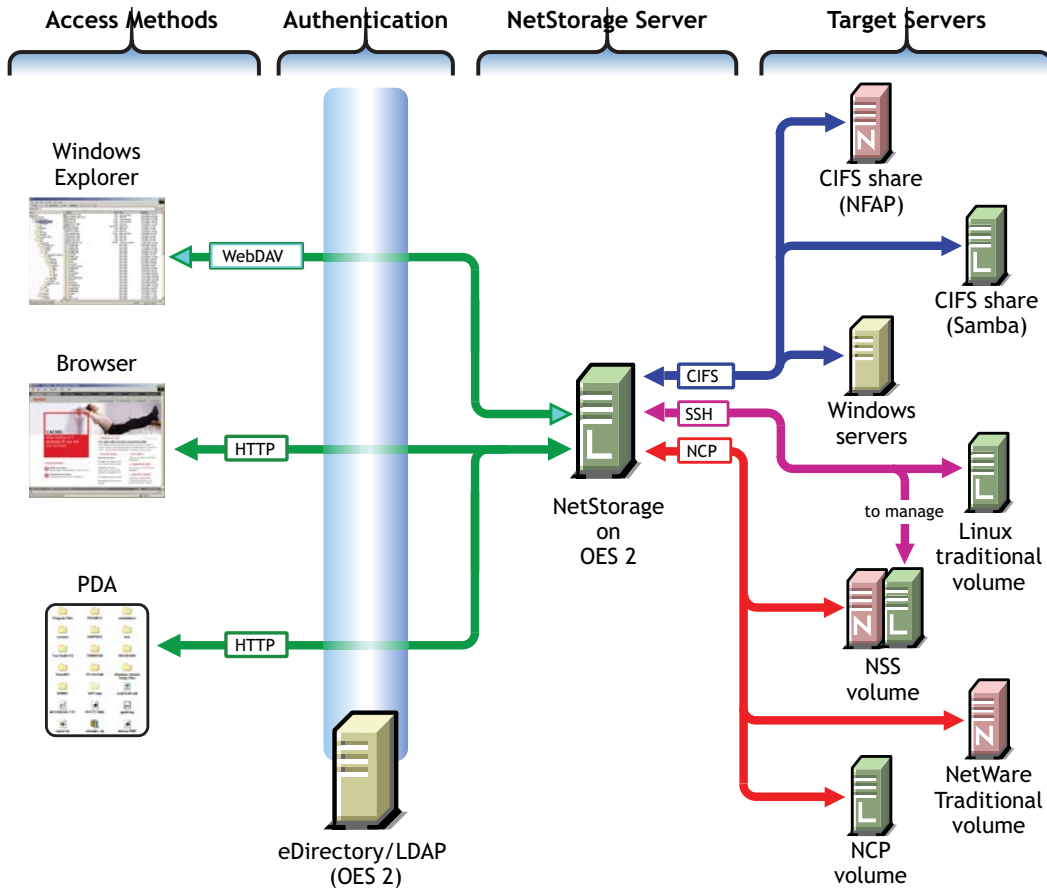

10.2 Making Directories Accessible Through NetStorage

NetStorage makes files on OES 2 servers available on the Internet. Directories can be made available as organizational needs dictate. For the exercises in this guide, we will focus on user home directories.

- ♦ [Section 10.2.1, "NCP Users Have Automatic Access to Their Home Directories,"](#) on page 86
- ♦ [Section 10.2.2, "Creating a Storage Location Object in iManager,"](#) on page 87
- ♦ [Section 10.2.3, "Adding the Object to a Storage Location List,"](#) on page 88
- ♦ [Section 10.2.4, "SSH and NetStorage Administration,"](#) on page 88

10.2.1 NCP Users Have Automatic Access to Their Home Directories

For users who have a home directory specified in eDirectory™ (on an NCP™ or NSS volume), access to that home directory is automatic.

By default, when users log in to NetStorage, they see a storage location named Home@TREE_NAME. This means that the ncp_*, the nss_* users, and the nw_edir user each see their home directories when they log into NetStorage.

The label that users see is configurable in the *File Access (NetStorage)* iManager plug-in by using the *NetWare Storage Provider* task. You can also specify home directories in additional trees if users log in to multiple trees. For more information, see “[NetWare Storage Provider](#)” in the *OES 2 SP3: NetStorage Administration Guide*.

TIP: The first time you access the *NetWare Storage Provider* task in iManager, the configuration is blank and the column headings are collapsed. To display the configuration, click *Set Defaults*, click another task, then click *NetWare Storage Provider* again. All of the columns are then displayed.

To make other directories on an OES 2 server available through NetStorage, including non-NCP/NSS home directories, you must create a Storage Location Object that points to the directory and then add the object to a Storage Location List as explained in the following sections.

10.2.2 Creating a Storage Location Object in iManager

A Storage Location object specifies an access protocol and points to a directory on either the NetStorage server itself or another accessible server. After object creation, users with rights to the directory can access storage location objects through NetStorage.

For connections to Storage Location objects, NetStorage supports both CIFS and SSH as alternatives to NCP (the default NetStorage protocol). Although they are used in this guide, SSH storage locations should only be used after certain security issues are understood and dealt with. (For more information, see “[SSH Security Considerations](#)” in the *OES 2 SP3: Planning and Implementation Guide*.)

Because the linux*_lum-edir users’ home directories are on a Linux traditional volume, there is no default access and you must create a Storage Location object for them to use.

Because the CIFS protocol on your getting-started lab server uses Novell CIFS, and because Novell CIFS provides access to only NSS volumes, the Storage Location object must use SSH.

To create an SSH Storage Location object:

- 1 Start iManager by entering the following URL in a browser Address field:

`http://IP_or_DNS/nps`

where *IP_or_DNS* is the IP address or DNS name of your OES 2 server.

If you receive a Tomcat error, see [Section A.2, “iManager Tomcat Error,”](#) on page 111.

- 2 Log in to iManager as the Admin user.
- 3 Click the *Roles and Tasks* icon .
- 4 Click *File Access (NetStorage) > New Storage Location*.
- 5 In the *Object Name* field, type

`StorLoc_hostname`

where *hostname* is the name of your getting-started lab server. This is the name of the Storage Location object in eDirectory (for example, `StorLoc_myserver`).

- 6 In the *Display Name* field, type

`Linux_Home_Directories`

This is the name that users see in the NetStorage directory access list.

- 7 In the *Directory Location* field, type

`ssh://IP_or_DNS_Name/home`



where *IP_or_DNS_Name* is the IP address or full DNS name of your getting-started lab server (for example, `ssh://myserver.mysite.company.example.com/home`).

IMPORTANT: Protocol designators, such as `ssh` and `cifs`, are case-sensitive on OES 2 servers. Make sure you don't type the common uppercase (`SSH` or `CIFS`) out of habit.

- 8 Click the *Browse* icon  next to the *Context* field.
- 9 Browse to and select the `SERVERS` Organizational Unit object.
The new Storage Location object will be created in the `SERVERS` organizational unit object.
- 10 Click *Create > OK*.

10.2.3 Adding the Object to a Storage Location List

Storage Location Lists are required for granting access for users, groups, or containers (Organizational Unit objects) to Storage Location objects.

- 1 In the list of tasks below File Access (NetStorage), click *Assign Storage Location to Object*.
- 2 Click the *Browse* icon  next to the *Object* field.
This field contains the user, group, or OU object that is granted access to the Storage Location object.
- 3 Click *USERS > OK*.
- 4 Click the *Browse* icon  next to the *Storage Location Objects* field.
- 5 Click the down-arrow  next to *SERVERS*.
- 6 Click the `StorLoc_hostname` object for your getting-started lab server, then click *OK*.
You could add multiple Storage Location objects to the list if needed, but we are only adding one.
- 7 Click *OK* twice.

10.2.4 SSH and NetStorage Administration

Many network administrators prefer to use SSH for remote server administration. NetStorage includes a special SSH-based Storage Location object named `NSS_Volumes` that lets eDirectory Admin users administer NSS volumes on OES 2 through NetStorage. Admin users can assign trustees, administer NSS file and directory attributes, restrict directory size, and so on.

As a general security precaution, SSH services are not enabled by default on OES 2 servers. However, you enabled SSH services through the firewall in [Section 4.4, "Allowing SSH Access," on page 58](#), and then you enabled SSH as a LUM-enabled service, thus giving SSH access to LUM-enabled users.

The eDirectory Admin user has SSH access because it is a LUM-enabled user by default. This means that the Admin user can use SSH for remote server administration and it can administer the server's NSS volumes through NetStorage.

NOTE: Unlike home directory access, which automatically connects all users in the tree with their NCP or NSS home directories no matter which server the directories are on, default administrative access is limited to the `nssvolumes` Storage Location object located in `COMPANY`. To provide administrative access to the `HOME_NW` volume on the `LAB_NW` NetWare® server, you would need to create an NCP Storage Location object that points to that volume.

Continue with [Chapter 11, "Getting Acquainted with OES,"](#) on page 91.

11 Getting Acquainted with OES

After you have installed Novell® Open Enterprise Server (OES) and completed the configuration instructions located in the preceding sections, your OES 2 server is ready for getting-started lab use.

The instructions and information in this section acquaint you with the basic services available in OES. More detailed service overviews are available in the *OES 2 SP3: Planning and Implementation Guide*. For comprehensive documentation for each service, see the administration guides and other documentation listed on the [OES documentation Web site \(http://www.novell.com/documentation/oes\)](http://www.novell.com/documentation/oes).

This section guides you through the following tasks:

- ◆ Section 11.1, “Preparing Files for the Getting-started Lab Exercises,” on page 91
- ◆ Section 11.2, “Exercises for linux1_lum-edir,” on page 92
- ◆ Section 11.3, “Exercises for linux2_lum-edir,” on page 94
- ◆ Section 11.4, “Exercises for ncp_lum-edir,” on page 96
- ◆ Section 11.5, “Exercises for ncp_edir,” on page 98
- ◆ Section 11.6, “Exercises for nss_edir,” on page 101
- ◆ Section 11.7, “Administrative Tasks Available in NetStorage,” on page 103
- ◆ Section 11.8, “Exercises for nss_lum-edir,” on page 104
- ◆ Section 11.9, “Exercises for nw_edir,” on page 106
- ◆ Section 11.10, “Macintosh Exercises and Novell AFP,” on page 107
- ◆ Section 11.11, “What’s Next,” on page 107

11.1 Preparing Files for the Getting-started Lab Exercises

You will use four small text files in the exercises that follow.

- 1 Log in to the Windows workstation as a Windows user with Administrator privileges.
- 2 Access this page in the online documentation.
- 3 Right-click each of the following links, select *Save Link (or Save Target) As*, and save the file to the desktop.
 - ◆ [MyPrivateFile.txt \(http://www.novell.com/documentation/oes2/download/MyPrivateFile.txt\)](http://www.novell.com/documentation/oes2/download/MyPrivateFile.txt)
 - ◆ [PublicInformation.txt \(http://www.novell.com/documentation/oes2/download/PublicInformation.txt\)](http://www.novell.com/documentation/oes2/download/PublicInformation.txt)

- ♦ [TeamProjectReadOnly.txt](http://www.novell.com/documentation/oes2/download/TeamProjectReadOnly.txt) (<http://www.novell.com/documentation/oes2/download/TeamProjectReadOnly.txt>)
 - ♦ [TeamProjectWrite.txt](http://www.novell.com/documentation/oes2/download/TeamProjectWrite.txt) (<http://www.novell.com/documentation/oes2/download/TeamProjectWrite.txt>)
- 4 If you are working on Windows 7, move the downloaded files to the *Libraries > Documents > Public Documents* folder on the workstation.
- Or
- If you are working on Windows XP, move the downloaded files to *My Computer > Shared Documents*.
- 5 Log off Windows.
- 6 Continue with the next section, [Exercises for linux1_lum-edir](#).

11.2 Exercises for linux1_lum-edir

- ♦ [Section 11.2.1, "What linux1_lum-edir Can Do,"](#) on page 92
- ♦ [Section 11.2.2, "Using NetStorage,"](#) on page 93

11.2.1 What linux1_lum-edir Can Do

This user has the following service access:

Table 11-1 *linux1_lum-edir Service Access*

Service	Details	Explored for This User in This Guide
Novell iFolder® 3.8	Can create and share its own iFolders and accept invitations from others to share their iFolders.	Yes. This was done previously in Section 8.5, “Configuring iFolder Accounts and Creating iFolders,” on page 76.
Novell AFP	Can access any NSS directories to which it has rights. Access rights to directories are governed by the NSS file system, allowing the user to only see and do what it has rights for.	See Section 11.10, “Macintosh Exercises and Novell AFP,” on page 107.
Novell CIFS	Can access any NSS directories to which it has rights. Access rights to directories are governed by the NSS file system, allowing the user to only see and do what it has rights for.	No
NetStorage	Can access NetStorage because of the Storage Location Object created in Section 10.2.2, “Creating a Storage Location Object in iManager,” on page 87. NetStorage provides this user with access to its home directory, which it would otherwise not have.	Yes, to demonstrate file copying and deleting. Also to show that the <code>linux2_lum-edir</code> directory is publicly available, and not private as a NetWare® administrator would expect it to be. In fact, the directory can also be written to by any member of the LUMUsers group because of the action you took in Step 15 on page 60.
iPrint	Can install and use the printer made available in Chapter 9, “iPrint,” on page 79.	No

11.2.2 Using NetStorage

- 1 Log in to the Windows workstation as the `linux1_lum-edir` user.
- 2 Close the iFolder window.
- 3 Open your browser and log into NetStorage by using the following URL:

`http://IP or DNS/netstorage`

where *IP or DNS* is your OES 2 server’s IP address or DNS name.

- 4 Type `linux1_lum-edir` as the *User Name*, type the associated password in the *Password* field, then click *OK*.
- 5 Select the `Linux_Home_Directories` storage location you created in [Section 10.2.2, “Creating a Storage Location Object in iManager,”](#) on page 87.
- 6 Open the `linux1_lum-edir` directory.
- 7 Click *File > Upload*.

NetStorage doesn’t support dragging and copying files. Instead you upload files you want to store from the workstation to the server, and you download files you want to work with from the server to the workstation.

- 8 If prompted, disable the pop-up blocker and click *File > Upload* again if necessary to open the Upload File dialog box.

- 9 Click the *Browse* button.
- 10 If you are using Windows XP, browse to the `Shared Documents` folder where you copied the four files in [Step 3 on page 91](#), select the first file and click *Open*.
If you are using Windows 7, browse to *Libraries > Documents*. Select the first file and click *Open*.
- 11 Click the plus (+) sign next to *Browse*, then repeat the same process to select and open the other three files.
- 12 Click the *Upload* button.
All four files should now be copied to the `linux1_lum-edir` directory.
- 13 Select the `linux2_lum-edir`, `ncp_edir`, and `ncp_lum-edir` folders in turn and attempt to copy the first file to each folder.
Because you assigned full rights the LUMUsers group in [Step 15 on page 60](#), the first copy attempt succeeds, but the other attempts fail because the `linux1_lum-edir` user doesn't have the necessary rights to the `ncp*` user folders.
- 14 Open the `linux1_lum-edir` folder, then select `MyPrivateFile.txt`.
- 15 Click *File > Delete > OK*.
The file is deleted.
- 16 Click *View > Show Deleted Files*.
The deleted file is not listed because this feature relies on the Salvage and Purge functionality that is available only on NSS volumes, and the underlying file system for the `/home` directory we are working with is Reiser, not NSS.
For more information on using NetStorage, see the [OES 2 SP3: NetStorage Administration Guide](#).
- 17 Continue with the next section, [Exercises for linux2_lum-edir](#).

11.3 Exercises for linux2_lum-edir

- ♦ [Section 11.3.1, "What linux2_lum-edir Can Do," on page 94](#)
- ♦ [Section 11.3.2, "Using NetStorage," on page 95](#)
- ♦ [Section 11.3.3, "Using iPrint," on page 96](#)

11.3.1 What linux2_lum-edir Can Do

This user has the following service access:

Table 11-2 *linux2_lum-edir Service Access*

Service	Details	Explored for This User in This Guide
iFolder 3.8	Can create and share its own iFolders and accept invitations from others to share their iFolders.	No
Novell AFP	Can access any NSS directories to which it has rights. Access rights to directories are governed by the NSS file system, allowing the user to only see and do what it has rights for.	See Section 11.10, "Macintosh Exercises and Novell AFP," on page 107.
Novell CIFS	Can access any NSS directories to which it has rights. Access rights to directories are governed by the NSS file system, allowing the user to only see and do what it has rights for.	No
NetStorage	Can access NetStorage because of the Storage Location Object created in Section 10.2.2, "Creating a Storage Location Object in iManager," on page 87. Otherwise, this user would not have access to its home directory because it was created manually as a POSIX directory rather than being specified in iManager.	Yes
iPrint	Can install and use the printer made available in Chapter 9, "iPrint," on page 79.	Yes

11.3.2 Using NetStorage

- 1 Log in to the Windows workstation as the `linux2_lum-edir` user.
- 2 When the iFolder wizard launches, click *Cancel*.
- 3 Open your browser. If you are running Windows 7, use the `Run as Administrator` option.
- 4 Log into NetStorage by using the following URL:

`http://IP or DNS/netstorage`

where *IP or DNS* is your OES 2 server's IP address or DNS name.

- 5 Type `linux2_lum-edir` as the *User Name*, type the associated password in the *Password* field, then click *OK*.
- 6 Click the `Linux_Home_Directories` storage location you created in [Section 10.2.2, "Creating a Storage Location Object in iManager,"](#) on page 87.
- 7 In the left navigation frame, click `linux2_lum-edir`.
- 8 Right-click the file in the right frame and notice that you can move, copy, download, delete, and rename the file through the NetStorage interface. Select *Properties*.
- 9 Notice that the file is owned by the `linux1_lum-edir` user who copied it to this folder.
- 10 Close the *Properties* window, right click the file again, and select *Delete*.
- 11 Click *OK*.

The file is deleted.

Although the file was owned by the `linux1_lum-edir` user who copied it to the folder, `linux2_lum-edir` can delete the file because it has all rights to the folder.

For a brief overview of what the different POSIX rights allow on directories and files, see “[Linux \(POSIX\) File System Access Rights](#)” in the *OES 2 SP3: Planning and Implementation Guide*.

- 12 Click *File > Upload*.
- 13 Click the *Browse* button, browse to the `Documents` folder, select the first file, and click *Open*.
- 14 Click the plus (+) sign next to *Browse*, and then repeat the same process to select and open the other three files.
- 15 Click the *Upload* button.

All four files should now be copied to the `linux2_lum-edir` directory.

For more information on using NetStorage, see the *OES 2 SP3: NetStorage Administration Guide*.

11.3.3 Using iPrint

- 1 In the browser, access the iPrint page by using the following URL:

`http://IP or DNS/ipp`

where *IP or DNS* is your OES 2 server’s IP address or DNS name.

IMPORTANT: If you are using Windows 7, you will need to run the browser as the administrator user.

- 2 (Conditional) If you have not previously installed the iPrint client on the workstation, click the *Install iPrint Client* link and install the client now.
- 3 Click the link for the printer you created in [Section 9.6, “Creating iPrint Printer Objects,” on page 83](#).
You might need to click the *Refresh* button to see the printers.
- 4 Answer the prompts to install the printer on the workstation.
- 5 Access the Printers property page.
On Windows 7 click *Start > Devices and Printers*.
On Windows XP click *Start > Settings > Printers*.
- 6 Right-click the printer, then click *Printer Properties*.
- 7 Click *Print Test Page > OK > OK*.
A test page should print at your printer.
For more information on various iPrint capabilities, see “[Customizing iPrint](#)” in the *OES 2 SP3: iPrint for Linux Administration Guide*.
- 8 Continue with the next section, [Exercises for ncp_lum-edir](#).

11.4 Exercises for ncp_lum-edir

- ♦ [Section 11.4.1, “What ncp_lum-edir Can Do,” on page 97](#)
- ♦ [Section 11.4.2, “Using NetStorage,” on page 97](#)

11.4.1 What ncp_lum-edir Can Do

This user has the following service access:

Table 11-3 ncp_lum-edir Service Access

Service	Details	Explored for This User in This Guide
iFolder 3.8	Can create and share its own iFolders and accept invitations from others to share their iFolders.	No
Novell AFP	Can access any NSS directories to which it has rights. Access rights to directories are governed by the NSS file system, allowing the user to only see and do what it has rights for.	See Section 11.10, “Macintosh Exercises and Novell AFP,” on page 107.
Novell CIFS	Can access any NSS directories to which it has rights. Access rights to directories are governed by the NSS file system, allowing the user to only see and do what it has rights for.	No
NetStorage	Can access its home directory through NetStorage because all home directories created through iManager and stored as attributes in eDirectory™ are exposed through the HOME@EXAMPLE_TREE default storage location.	Yes
iPrint	Can install and use the printer made available in Chapter 9, “iPrint,” on page 79.	No

11.4.2 Using NetStorage

- 1 Log in to the Windows workstation as the ncp_lum-edir user.
- 2 When the iFolder wizard launches, click *Cancel*.
- 3 Open your browser and log into NetStorage by using the following URL:

`http://IP or DNS/netstorage`

where *IP or DNS* is your OES 2 server’s IP address or DNS name.

- 4 Type ncp_lum-edir as the *User Name*, type the associated password in the *Password* field, then click *OK*.
- 5 Click the HOME@EXAMPLE_TREE storage location.
Unlike the Linux_Home_Directories storage location, this directly opens the home directory.
- 6 Click *File > Upload*, browse to the Documents folder, and upload one of the text files.
The file appears in the folder.
- 7 Click the ncp_lum-edir folder in the Linux_Home_Directories storage location.
Notice that the folder appears to be empty.

This is because the ncp_lum-edir home directory was created when the user object was created in iManager by the eDirectory Admin user. The ncp_lum-edir user can see that the directory exists because it is a member of the LUMUsers group and has SSH access to the /home directory on the OES 2 server, but it has no POSIX rights to view the ncp_lum-edir directory's contents. From a POSIX perspective, the Admin user owns the directory.

- 8 Click the linux2_lum-edir folder in the Linux_Home_Directories storage location.

Notice that the four files uploaded by the user in [Step 12 on page 96](#) are listed.

This is because the ncp_lum-edir user is a member of the LUMUsers group, and that group has all rights to linux2_lum-edir's home directory as assigned in [Step 16 on page 60](#).

For more information on using NetStorage, see the [OES 2 SP3: NetStorage Administration Guide](#).

11.5 Exercises for ncp_edir

- ♦ [Section 11.5.1, "What ncp_edir Can Do," on page 98](#)
- ♦ [Section 11.5.2, "Using iFolder," on page 99](#)
- ♦ [Section 11.5.3, "Using NetStorage," on page 100](#)

11.5.1 What ncp_edir Can Do

This user has the following service access:

Table 11-4 ncp_edir Service Access

Service	Details	Explored for This User in This Guide
iFolder 3.8	Can create and share its own iFolders and accept invitations from others to share their iFolders.	Yes
Novell AFP	Can access any NSS directories to which it has rights. Access rights to directories are governed by the NSS file system, allowing the user to only see and do what it has rights for.	See Section 11.10, "Macintosh Exercises and Novell AFP," on page 107 .
Novell CIFS	Can access any NSS directories to which it has rights. Access rights to directories are governed by the NSS file system, allowing the user to only see and do what it has rights for.	No
NetStorage	Can access its home directory through NetStorage because all home directories created through iManager and stored as attributes in eDirectory are exposed through the HOME@EXAMPLE_TREE default storage location.	Yes
iPrint	Can install and use the printer made available in Chapter 9, "iPrint," on page 79 .	No

11.5.2 Using iFolder

- ♦ [“Setting Up iFolder” on page 99](#)
- ♦ [“Observing File Synchronization” on page 99](#)
- ♦ [“Using iFolder Web Access” on page 100](#)

Setting Up iFolder

linux2_lum-edir has full access to all iFolder user functionality, but for the purposes of this guide we will accept only the invitation that was extended by linux1_lum-edir and briefly explore what is available through that invitation.

- 1 At the Windows workstation, log in as ncp_edir.
- 2 After the iFolder Account Creation Wizard launches, click *Next*.
- 3 In the *Server Address* field, type the IP address or DNS name of the OES 2 getting-started lab server, then click *Next*.
- 4 Type the username and password for ncp_edir, select *Remember password on This Computer*, then click *Next*.
- 5 Click *Connect*.
- 6 If prompted, accept the certificate by clicking *Yes*.
- 7 Deselect *Create Default iFolder*, then click *Next*.
- 8 Click *Finish*.
- 9 Right-click in the iFolder dialog box and select *Refresh*, then click *linux1_lum-edir_IF3*.
Remember that this is the iFolder that linux1_lum-edir shared with the ncp_edir user.
- 10 In the icon row at the top, click *Download*.
- 11 Click *OK*.
The iFolder is created on the desktop.
- 12 Double-click the iFolder on the desktop to open it in Windows Explorer.
- 13 Navigate to the *Documents* folder, then drag and copy (using the Ctrl key) the four files to the *linux1_lum-edir_IF3* folder.
You can do this because ncp_edir has default Read/Write permissions to the shared iFolder.
Make sure you copy (by pressing the Ctrl key) rather than moving the files from the Shared Documents folder. Otherwise, the files will be moved and won't be available to other users who log in.
- 14 Continue with the next section, [“Observing File Synchronization.”](#)

Observing File Synchronization

To understand more about how iFolder works, it is helpful to observe the file synchronization processes in action.

- 1 On the desktop in the taskbar, right-click the iFolder icon and select *Synchronization Log*.
The iFolder Synchronization Log opens.
- 2 Right-click the iFolder icon again and select *Preferences*.
- 3 Change the *Synchronization* interval to 1 minute and click *Apply*.

Normally you would not want to synchronize this often, but for our current purposes it helps to expedite log activity.

- 4 Delete the `MyPrivateFile.txt` file from the `linux1_lum-edir` iFolder on the desktop.

Within a couple of minutes the change is synchronized with the iFolder server. Notice that there are various synchronization operations involved to ensure that all changes are tracked in order and coordinated among the various iFolders on the server and affected workstations.

- 5 Continue with the next section, "[Using iFolder Web Access.](#)"

Using iFolder Web Access

NOTE: By default, interaction with an iFolder 3.8 server is encrypted through SSL 3.0.

Users can access their iFolders through most browsers that support SSL 3.0.

- 1 Open your browser and enter the following URL:

`https://IP_or_DNS_name/ifolder`

where *IP_or_DNS_name* is the IP address or complete DNS name of your OES 2 server.

- 2 If prompted, accept the certificate.

- 3 Log in as `ncp_edir`.

- 4 Click the `linux1_lum-edir_IF3` link and observe the following:

- ♦ The files you copied to the iFolder are available in the browser.
- ♦ By clicking a file link, you can automatically download and open the file, or you can save it to your desktop. After downloading and modifying a file, you can upload it and replace the original on the iFolder server.
- ♦ Using the links above the files, you can create new folders, upload files, and delete a selected file from the server.

Changes made to iFolders on the server through browser connections are synchronized with the corresponding iFolders on workstation desktops the next time users log in.

- 5 Close the browser.

- 6 Continue with the next section, "[Using NetStorage.](#)"

11.5.3 Using NetStorage

- 1 Using your browser, log into NetStorage by using the following URL:

`http://IP or DNS/netstorage`

where *IP or DNS* is your OES 2 server's IP address or DNS name.

- 2 Type `ncp_edir` as the *User Name* and the associated password in the *Password* field, then click *OK*.

- 3 In the left navigation frame, click `Home@EXAMPLE_TREE`.

- 4 Click `File > Upload`.

If you are prompted, enable pop-ups and repeat this step.

- 5 Click the *Browse* button and navigate to the *Shared Documents* folder, then select the first file and click *Open*.

- 6 Click the *Plus* sign (+) by the *Browse* button to add another field. Then click *Browse*, select the next file, and repeat this step until all four files are selected.
- 7 Click *Upload*.
- 8 Log in to the OES 2 server as the *root* user and click *Computer > Home Folder*.
- 9 Double-click *File System > home > ncp_edir*.
- 10 Verify that the files you copied in NetStorage are on the server.
- 11 Right-click a file, select *Properties*, then click the *Permissions* tab and observe the following:
 - ♦ The *File Owner* is *root*.
 - ♦ The *File Group* is *root*.
 - ♦ *Group* and *Others* have no rights, reflecting the fact that the file is on an NCP™ volume.Generally speaking, these POSIX permissions do not cause any problems. They do not affect NetStorage functionality for the user in this configuration because *Home@EXAMPLE_TREE* is an NCP storage location object; NCP file and directory trustee assignments govern access, not POSIX permissions. If the user accesses the files through a Novell Client™, NCP assignments govern.
- 12 On the getting-started lab workstation, in NetStorage, click the *Linux_Home_Directories* storage location.

After a few moments, a message displays indicating that NetStorage cannot access the location. This is because the *ncp_edir* user is not LUM-enabled and therefore has no SSH access to the server.
- 13 Continue with the next section, [Exercises for nss_lum-edir](#).

11.6 Exercises for nss_edir

- ♦ [Section 11.6.1, “What nss_edir Can Do,” on page 101](#)
- ♦ [Section 11.6.2, “Using NetStorage,” on page 102](#)

11.6.1 What nss_edir Can Do

This user has the following service access:

Table 11-5 *nss_edir* Service Access

Service	Details	Explored for This User in This Guide
iFolder 3.8	Can create and share its own iFolders and accept invitations from others to share their iFolders.	No
Novell AFP	Can access any NSS directories to which it has rights. Access rights to directories are governed by the NSS file system, allowing the user to only see and do what it has rights for.	See Section 11.10, “Macintosh Exercises and Novell AFP,” on page 107.
Novell CIFS	Can access any NSS directory to which it has rights. Access rights to directories are governed by the NSS file system, allowing the user to only see and do what it has rights for.	Yes
NetStorage	Can access its home directory through NetStorage because all home directories created through iManager and stored as attributes in eDirectory are exposed through the HOME@EXAMPLE_TREE default storage location.	Yes
iPrint	Can install and use the printer made available in Chapter 9, “iPrint,” on page 79.	No

11.6.2 Using NetStorage

- 1 Log in to the Windows workstation as the `nss_edir` user.
- 2 When the iFolder wizard launches, click *Cancel*.
- 3 On the Windows workstation in your browser, log into NetStorage by using the following URL:

`http://IP or DNS/netstorage`

where *IP or DNS* is your OES 2 server’s IP address or DNS name.

- 4 Type `nss_edir` as the *User Name*, type the associated password in the *Password* field, then click *OK*.
- 5 In the left navigation frame, click *Home@EXAMPLE_TREE*.
This share point links directly to the NSS home directory for the user that is specified in eDirectory.
- 6 Click *File > Upload*.
If needed, allow the pop-up and repeat this step.
- 7 Click the *Browse* button and navigate to the *Shared Documents* folder, then select the first file and click *OK*.
- 8 Click the *Plus* sign (+) by the *Browse* button to add another field. Then click *Browse*, select the next file, and repeat this step until all four files are selected.
- 9 Click *Upload*.
- 10 Select `MyPrivateFile.txt`, then click *File > Rename* and rename the file to `junk.txt`.

- 11 Upload `MyPrivateFile.txt` again.
- 12 Right-click `junk.txt` and select *Delete*, then click *OK*.

The file is removed from the list, but because this is an NSS volume with Salvage enabled, the file is not gone from the NSS file system.
- 13 Click *View > Show Deleted Files*.
- 14 Select `junk.txt`, then click *File > Undelete*.

In Internet Explorer 8 you must allow the Windows script to run and repeat this step.
- 15 Click *OK*.

Notice that the file is still displayed as a deleted file and an error is indicated in the lower left frame.

This is because NSS cannot track POSIX ownership of files for users that are not LUM-enabled. For more information, see “[Services That Do Not Require LUM-Enabled Access But Have Some LUM Requirements](#)” in the *OES 2 SP3: Planning and Implementation Guide*.

If `nss_edir` were using the Novell Client, the file could be salvaged through the client, but because we are not exploring the Novell Client in this guide, this is a good place to look at a few of the administrative features for NSS volumes that are available to eDirectory Admin users through NetStorage.
- 16 Continue with the next section, [Administrative Tasks Available in NetStorage](#).

11.7 Administrative Tasks Available in NetStorage

- ♦ [Section 11.7.1, “Recovering the junk.txt File,” on page 103](#)
- ♦ [Section 11.7.2, “Setting Rights to TeamProjectReadOnly.txt,” on page 103](#)
- ♦ [Section 11.7.3, “Setting Rights to TeamProjectWrite.txt,” on page 104](#)

11.7.1 Recovering the junk.txt File

- 1 Log in to NetStorage as the eDirectory Admin user and browse to the `nss_edir` home directory.
- 2 Click *View > Show Deleted Files*.
- 3 Select `junk.txt`.
- 4 Click *File > Undelete*, then click *OK*.

In Internet Explorer 8 you must allow the Windows script to run and repeat this step.
- 5 Click *View > Refresh*.

You might have to refresh the Windows to see the deleted file.

The file has been fully recovered.

11.7.2 Setting Rights to TeamProjectReadOnly.txt

- 1 Right-click `TeamProjectReadOnly.txt` and select *Properties*.
- 2 Click *NetWare Rights*.

This displays the Novell File Trustee assignments for the file.
- 3 Click the *Browse* icon next to the blank field under the *Trustees* list.

4 Click *EXAMPLE_TREE > COMPANY > LAB > USERS > AllUsers*.

5 Click the plus sign, then click the *NetWare Rights* tab again.

The AllUsers group members are now trustees of the *TeamProjectReadOnly.txt* file in the *nss_edir* home directory.

Notice the check boxes to the right of the AllUsers group, indicating that the group has Read and File Scan rights to the file.

6 Click *Apply > Close*.

7 Continue with [Setting Rights to TeamProjectWrite.txt](#).

11.7.3 Setting Rights to TeamProjectWrite.txt

1 If the previous file is still selected, deselect it. Right-click options are only available on single files and are prevented if multiple files are selected.

2 Right-click *TeamProjectWrite.txt* and select *Properties*.

3 Select *Rename Inhibit*, select *Delete Inhibit*, then click *Apply*.

The NSS file system is now set to prevent the file from being renamed or deleted by anyone, including *nss_edir*.

4 Click *NetWare Rights*.

5 Click the *Browse* icon next to the blank field.

6 Click *EXAMPLE_TREE > COMPANY > LAB > USERS > LUMUsers*.

7 Click the plus sign (+), then click the *NetWare Rights* tab again.

The LUMUsers group members are now trustees of the *TeamProjectWrite.txt* file in the *nss_edir* home directory.

Notice the check boxes to the right of the LUMUsers group, indicating that the group has Read and File Scan rights to the file.

8 Assign the group the Write right by selecting the check box to the right of the first one that is checked (the Read check box).

9 Click *Apply > Close*.

10 Continue with the next section, [Exercises for nss_lum-edir](#).

11.8 Exercises for nss_lum-edir

- ♦ [Section 11.8.1, "What nss_lum-edir Can Do,"](#) on page 104
- ♦ [Section 11.8.2, "Using Novell CIFS File Services,"](#) on page 105

11.8.1 What nss_lum-edir Can Do

This user has the following service access:

Table 11-6 *nss_lum-edir Service Access*

Service	Details	Explored for This User in This Guide
iFolder 3.8	Can create and share its own iFolders and accept invitations from others to share their iFolders.	No
Novell AFP	Can access any NSS directories to which it has rights. Access rights to directories are governed by the NSS file system, allowing the user to only see and do what it has rights for.	See Section 11.10, "Macintosh Exercises and Novell AFP," on page 107.
Novell CIFS	Can access any NSS directory to which it has rights. Access rights to directories are governed by the NSS file system, allowing the user to only see and do what it has rights for.	Yes
NetStorage	Can access its home directory through NetStorage because all home directories created through iManager are stored as attributes in eDirectory are made available through the HOME@EXAMPLE_TREE default storage location.	No
iPrint	Can install and use the printer made available in Chapter 9, "iPrint," on page 79.	No

11.8.2 Using Novell CIFS File Services

- 1 Log in to the Windows workstation as the `nss_lum-edir` user.
- 2 When the iFolder wizard launches, click *Cancel*.
- 3 On Windows 7, click *Start > Computer > Map Network Drive*.
On Windows XP, open Windows Explorer or My Computer and click *Tools > Map Network Drive*.
- 4 Click the *Drive* drop-down list and select an unused drive letter.
- 5 In the *Folder* field, type the following:

```
\\IP_or_DNS\home_nss.
```

where *IP_or_DNS* is the IP address or full DNS name of the OES 2 server.

- 6 Click *Finish*.
The system maps the drive and opens at the root of the `HOME_NSS` volume.
Normally, only the `nss_lum-edir` home directory would appear. However, because we granted rights to two files in the `nss_edir` home directory, it also appears.
- 7 Open the `nss_edir` home directory and notice that the two files are displayed, but the other files in `nss_edir` are not.
This illustrates the granular access capabilities of NCP file services.
- 8 Open the `TeamProjectReadOnly.txt` file in a text editor, such as Notepad. Then change the file contents and try to save the changes.

You are prevented from doing anything except reading the file, including saving the file with a different name.

9 Open the `TeamProjectWrite.txt` file in the text editor. Then change the file contents and save the file.

10 Close the file and reopen it in the editor.

Your changes were saved because of the rights you have to the file.

11 Close the file and try to delete it.

Windows 2000 and some versions of Windows XP wrongly report that the file has been deleted. However, if you close the drive and reopen it, you will see that it is still there. See "[Windows XP SP2 Wrongly Reports File Deletion](#)."

12 Continue with the next section, [Exercises for nw_edir](#).

11.9 Exercises for nw_edir

- ♦ [Section 11.9.1, "What nw_edir Can Do,"](#) on page 106
- ♦ [Section 11.9.2, "Using NetWare CIFS File Services,"](#) on page 107

11.9.1 What nw_edir Can Do

This user has the following service access:

Table 11-7 *nw_edir Service Access*

Service	Details	Explored for This User in This Guide
iFolder 3.8	Can create and share its own iFolders and accept invitations from others to share their iFolders.	No
NetWare AFP	Can access any NSS directories to which it has rights. Access rights to directories are governed by the NSS file system, allowing the user to only see and do what it has rights for.	No
NetWare CIFS	Because its home directory is on the virtualized NetWare server, this user has automatic CIFS/SMB access to the directory (assuming the configuration steps in Section 7.2, "Enabling NFAP Services on the LAB_NW Server," on page 70 are completed.)	Yes
NetStorage	Can access its home directory through NetStorage because all home directories created through iManager are stored as attributes in eDirectory are made available through the HOME@EXAMPLE_TREE default storage location.	No
iPrint	Can install and use the printer made available in Chapter 9, "iPrint," on page 79.	No

11.9.2 Using NetWare CIFS File Services

- 1 Log in to the Windows workstation as the `nw_edir` user.
- 2 When the iFolder wizard launches, click *Cancel*.
- 3 Open Windows Explorer or My Computer and click *Tools > Map Network Drive*.
- 4 Click the *Drive* drop-down list and select an unused drive letter.
- 5 In the *Folder* field, type the following:

```
\\IP_or_DNS\home_nw
```

where `IP_or_DNS` is the IP address or full DNS name of the `LAB_NW` server.

TIP: After doing so many exercises involving the OES 2 Getting-started Lab server, it is easy to use the wrong IP address or DNS name. Make sure you are accessing your virtualized NetWare server.

- 6 Click *Finish*.
The system maps the drive and opens at the root of the `HOME_NW` volume.
- 7 Navigate to the `Shared Documents` folder, then drag and copy the four files to the `nw_edir` folder.
- 8 Continue with the next section, [Macintosh Exercises and Novell AFP](#).

11.10 Macintosh Exercises and Novell AFP

Most of the exercises you have performed in this guide can also be performed on a Macintosh workstation, so we will not repeat them.

OES 2 includes iPrint and iFolder clients for the Mac, and NetStorage and iFolder Web services work equally well on most browsers, including those on mobile devices.

Novell CIFS even works well with the Macintosh file sharing functionality.

To explore Novell AFP on your getting-started lab's Macintosh workstation, do the following:

- 1 While logged into the workstation, click the Finder, then click *Go > Connect to Server*.
- 2 In the Connect to Server dialog box, type the OES 2 server's IP address or DNS name, then click *Connect*.
- 3 Type an `nss*` user's name and password and click *Connect*.

You should see the folders on the `HOME_NSS` volume to which the user has access rights.

11.11 What's Next

Your getting-started lab is now set up and ready to use for building your experience with OES 2.

The exercises in this guide have highlighted only a few major points and features. There are numerous additional things worth exploration.

After you complete the exercises in this guide, we recommend that you do the following:

1. Think about the needs of your organization and how the various OES 2 product components can help you address those needs.

2. Think about your network users and their file and print service needs. Match them against the different user types created in this guide. Then take the opportunity to do some hands-on exploring of the access capabilities and limitations for the matching users. For example, set up and experiment with the privacy and collaboration capabilities for each user through both NCP and POSIX.
3. Begin planning your organization's eDirectory tree and the rollout of OES 2 services to your organization.

As you plan for, work with, and install OES 2, be sure to consult the other OES 2 product documentation mentioned in ["If You Want to Use This Guide as a Reference" on page 8](#).

A Supplementary Information

This section contains supplementary explanations and instructions.

- ♦ Section A.1, “NSS Partitions, Pools, and Volumes,” on page 109
- ♦ Section A.2, “iManager Tomcat Error,” on page 111

A.1 NSS Partitions, Pools, and Volumes

For a complete discussion about NSS, refer to the [OES 2 SP3: NSS File System Administration Guide for Linux](#).

This section presents the following:

- ♦ A quick overview of the three Linux partitions on your getting-started lab server
- ♦ A general overview of NSS partitions and the mechanisms that let you create NSS volumes on them

Figure A-1 Partitions, Pools, and Volumes

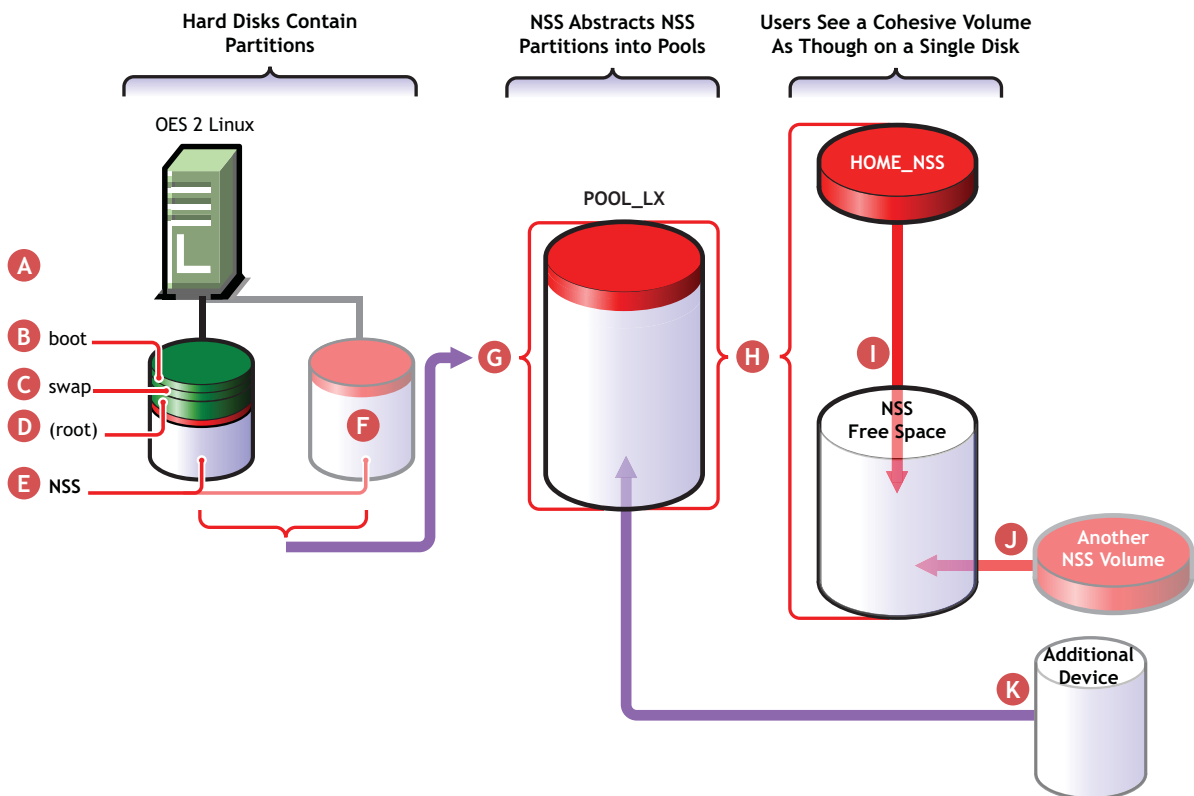

Reference Letter	Explanation
------------------	-------------

- | | |
|----------|--|
| A | Partitions are physical sections on a hard disk that are managed by a file system. The most common file systems on Linux servers today are Ext3, Reiser, and XFS. |
| B | The boot partition on your getting-started lab server is managed by the Reiser file system. The files and configuration data it contains start the server. |
| C | The swap partition is managed by a file system that swaps information between memory and the disk, thus augmenting the RAM installed in the server. |
| D | The / (root) partition on your server is managed by Reiser and stores all the getting-started lab server's system and data files, including OES services, eDirectory™, and so on. |
| E | <p>OES 2 servers can also include NSS partitions. These are similar to Linux partitions in that they occupy physical disk space, but they are also significantly different in a number of ways.</p> <ol style="list-style-type: none">1. You create the Linux partitions shown in this illustration during OES 2 installation.

You always create NSS partitions after the OES installation is completed.2. You create Linux partitions by allocating an amount of disk space to the partition and assigning it a mount point, such as /boot, /home, or / (root).

You create NSS partitions by creating an NSS pool (see G) and assigning space on the server's storage devices (physical or logical disks) to the pool. The space you assign to a given pool from a specific disk is designated on that disk as an NSS partition.3. On Linux, files are stored on a partition.

On NSS, files are stored in an NSS volume—a logical mechanism that can span multiple NSS partitions and also the devices that contain them.4. On Linux, a partition is allocated a set amount of disk space on a single device. The amount of disk space that can be used is limited by the size of the partition.

NSS volumes are not bound by individual partition or device sizes. Rather, they take disk space from their assigned NSS pool as needed. |
| F | <ol style="list-style-type: none">1. Additional disk space can be dynamically added to NSS pools as needed, and NSS volumes can grow dynamically in return as long as there is free space available in the pool, unless the volume size has been restricted by an eDirectory Admin user. |

IMPORTANT: The illustration shows the NSS pool spanning NSS partitions on both the server's primary hard disk and a second hard disk, which could be added later. The NSS pool contains an NSS volume (HOME_NSS in this case) that contains the NSS volume data (illustrated in red). The NSS pool also has free space that is not yet allocated to a volume (illustrated in white).

Free space and volume data aren't necessarily distributed across all partitions, or distributed evenly as the graphic might imply. The NSS file system manages what each partition contains, independent of any administrative controls.

Reference Letter	Explanation
G	<p>The NSS file system logically combines multiple partitions to form pools of space (up to 8 TB in size) that can span multiple devices.</p> <p>In the illustration, POOL_LX contains two NSS partitions that are created from the unformatted space on both hard disks when the pool is created.</p> <p>In some ways, NSS pools are like pools of water. The space from each partition is logically “poured” into an NSS pool and made available to the pool’s assigned volumes, such as HOME_NSS. Neither the volume nor the users with rights to access it know which physical partitions contain the disk space actually being used.</p> <p>Of course, the NSS file system continues to track each partition below the surface, but from a logical standpoint, all of the disk space assigned to a pool is one continuous source of disk space.</p>
H	<p>The sole purpose of NSS pools is to provide storage space from which you can form one or more NSS volumes.</p> <p>Your getting-started lab server contains a single NSS pool named POOL_LX with a single NSS volume named HOME_NSS. The pool’s free space is unallocated until used.</p>
I	<p>The instructions for creating the HOME_NSS volume leave the option set to have the volume grow to the pool size. As additional space is needed, the HOME_NSS volume automatically expands into the free space shown.</p>
J	<p>Free space in the pool is not reserved for the HOME_NSS volume; instead, space is allocated to HOME_NSS as needed. You can optionally add other volumes to the same pool and, in a sense, “overbook” the pool’s free space.</p>
K	<p>You can also grow the pool as needed by adding more NSS partitions to the pool.</p>

A.2 iManager Tomcat Error

If you experience a Tomcat error when attempting to access iManager 2.7, the likely cause is a corrupted browser cookie. Clearing the browser cookies should solve the problem.

- 1 In Firefox, click *Tools > Clear Private Data*.
- 2 Select *Cookies*.
- 3 Deselect the other options.
- 4 Click *Clear Private Data Now*.

B Documentation Updates

This section summarizes the changes made to this guide since the initial release of Novell® Open Enterprise Server 2.

April 17, 2012

Chapter or Section Changed	Summary of Changes
Section 9.3, "Creating a Print Driver Store," on page 81	Added a link to information in the iPrint administration guide about the <i>Add from File</i> option.

January 18, 2012

Chapter or Section Changed	Summary of Changes
Various.	Updated format to comply with new corporate standard.

September 2011

Chapter or Section Changed	Summary of Changes
Various.	Updated contents for change to SLES 10 SP4 as the install base for OES 2 SP3.

December 2010

Chapter or Section Changed	Summary of Changes
Various.	Updated contents for OES 2 SP3.

January 19, 2010

Chapter or Section Changed	Summary of Changes
Various.	Editing changes for SP2.

December 17, 2009

Chapter or Section Changed	Summary of Changes
"Identifying the Files to Download" on page 11.	The media filenames for OES 2 SP2 now show SP2a to indicate that they are updated to resolve a problem with the NCP Server object, which involves Novell Clustering and has no impact on this guide.

November 9, 2009

Chapter or Section Changed	Summary of Changes
Various.	Updated guide contents for OES 2 SP2.

May 20, 2009

Chapter or Section Changed	Summary of Changes
"Identifying the Files to Download" on page 11.	<p>The media filenames for OES 2 SP1 Linux now show SP1b to indicate that they are updated for:</p> <ul style="list-style-type: none">◆ Compatibility with all of the patches in the OES 2 update channel.◆ Correction of a build problem with the SP1b media. See May 11, 2009. <p>For more details, see TID 7003153 on the Novell Support site.</p>

May 11, 2009

Chapter or Section Changed	Summary of Changes
"Identifying the Files to Download" on page 11.	<p>The media filenames for OES 2 SP1 Linux now show SP1a to indicate that they are updated for compatibility with all of the patches in the OES 2 update channel.</p> <p>For more details, see TID 7003153 on the Novell Support site.</p>

March 5, 2009

Chapter or Section Changed	Summary of Changes
"Creating a Storage Location Object in iManager" on page 87.	Clarified statements regarding Novell CIFS and SSH as used in the creation procedure. Corrected the protocol used to create the Storage Location Object from CIFS to SSH.
